

Science with Passion

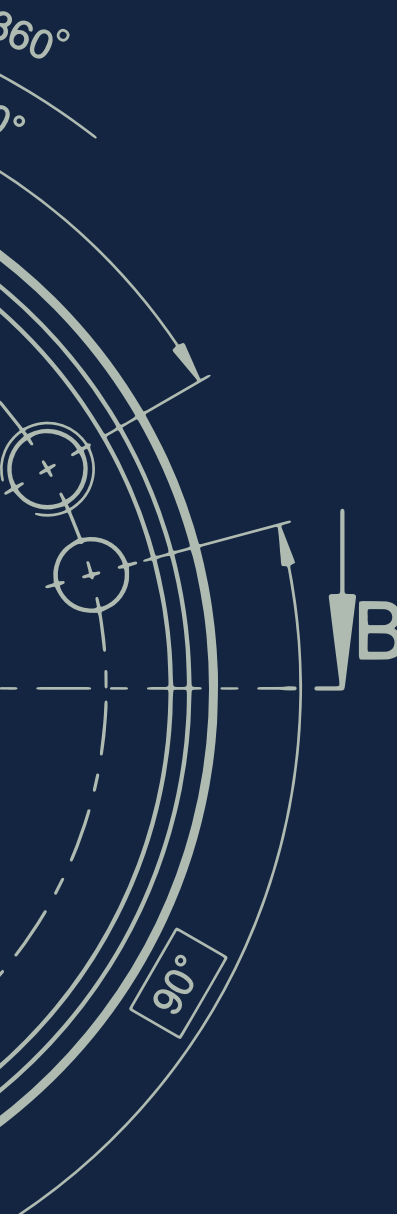

Dosing Pump Selection Guide

2022/2023

High-pressure dosing pumps, detectors, flow meters, valves and accessories for a wide range of dosing applications



Get in touch

Sales

If you want to learn more about our products and services or get a quote, the experts from our sales team are happy to assist you with your request.

Phone: +49 30 809727-0 (workdays 9-17h CET)

Fax : +49 30 8015010

E-mail: sales@knauer.net

Support

Do you have questions about the installation or the operation of your device or software?

International Support:

Contact your local KNAUER partner for support:

www.knauer.net/en/Support/Distributors-worldwide

Support in Germany

Phone: +49 30 809727-111 (workdays 9-17h CET)

Fax : +49 30 8015010

E-mail: support@knauer.net



Disclaimer

Technical data or prices are subject to change without notice. Prices may vary by country and do not include taxes, customs duties or delivery. All trademarks are the property of their respective owners. Our general terms and conditions apply: www.knauer.net/terms.

Welcome to KNAUER



About KNAUER

Based in Berlin, KNAUER is a medium-sized company that has been serving the sciences since 1962. We develop and manufacture scientific instruments of superior quality for liquid chromatography and other laboratory tasks. The product range includes systems and components for analytical HPLC/UHPLC, preparative HPLC, fast protein liquid chromatography (FPLC), multi-column chromatography/simulated moving bed (SMB), as well as equipment for high-pressure dosing and osmometry.

Sustainability & ecological commitment

We are committed to protect the environment for ourselves and our children. KNAUER contributes to the conservation of a healthy environment by basing our work on an environmental management system according to DIN EN ISO 14001. The KNAUER quality management system according to DIN EN ISO 9001 makes sure that we continuously manufacture products in the best quality possible. As a family business with about 160 employees, KNAUER focuses on sustainability and takes responsibility for our future.

Some of our ecological activities:

- The regular creation of an input and output balance for the determination and evaluation of energy and resource flows
- Environmentally friendly product development, energy-efficient production, and shipping with biodegradable packaging materials and re-usable packaging with local suppliers
- Fixed specifications for the development of new products according to ecological aspects such as low solvent consumption, repairability, and longevity of the products
- Complete modernization of the company building included thermal insulation, new windows, electric blinds, and a green rooftop, which resulted in a 50 % heating energy saving
- 100 % green electricity and generation of solar power with our photovoltaic system on the roof
- Guidelines for business travel from an environmental, economic, and social perspective
- Tips and instructions for clients to reduce solvent consumption during instrument use
- Environmentally compatible working and manufacturing of HPLC instruments and accessories, e.g. by using energy-efficient working equipment and reducing the use of solvents and harmful substances
- A life cycle assessment to optimize the manufacturing process and concentrate on electricity saving components

Sustainability: #KNAUERforFuture

Many KNAUER employees have good ideas for sustainability, and so we all get better together every year. We would like to inspire YOU to implement sustainability in many areas of your company, too. May these short videos keep you entertained and invite you to act! www.knauer.net/sustainable.

Table of contents

Dosing pump configurator	1
Overview	2
High-pressure dosing pumps	2
Flow-pressure range	3
Chemical compatibility	4
Pump control	5
Accurate dosing for demanding applications	5
Temperature control	6
High-temperature dosing	6
Regulated environments	6
Dosing Pumps	7
BlueShadow Pump 40P	7
BlueShadow Pump 80P	9
AZURA® Pump P 2.1S	12
AZURA® Pump P 4.1S	14
Mass flow controllers	16
Detectors	17
BlueShadow Detector 40D	17
BlueShadow Detector 50D	18
AZURA® Valve Drive VU 4.1	19
Valves for valve drive VU 4.1	20

Accessories	21
Pump heads and pump head accessories	21
Pump head compatibility	22
Pump accessories	25
Detector accessories	29
Consumables	31
Software	40
Mobile Control (Chrom) for Windows 10	40
Services	41
Consulting	41
Maintenance	41
Self service training	41
Flow rate calibration	41
Rebuild service	41
Technical Support	41
Conversion tables	42
Chemical compatibility of wetted parts	43
Terms and conditions	47
KNAUER Brochures	50

Dosing pump configurator

CONNECTIONS:

	Inlet port	Outlet port
1/16"	<input type="checkbox"/>	<input type="checkbox"/>
1/8"	<input type="checkbox"/>	<input type="checkbox"/>
1/4"	<input type="checkbox"/>	<input type="checkbox"/>
Other:	<input type="checkbox"/>	<input type="checkbox"/>

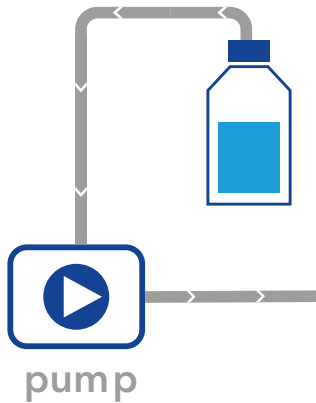

PRESSURE:

Inlet pressure ambient
 positive: bar

Max. outlet pressure bar

PUMP:

Max. flow rate ml/min

Min. flow, continuous ml/min

Quantity of pumps

LIQUIDS:

Liquids

(please specify concentration)

Temperature °C

Viscosity mPa s

OTHER REQUIREMENTS:

Chemical compatibility specifications		
Extended material documentation	<input type="checkbox"/> Yes	<input type="checkbox"/> No
GMP compliant	<input type="checkbox"/> Yes	<input type="checkbox"/> No
Pressure sensor	<input type="checkbox"/> Yes	<input type="checkbox"/> No
Mass flow controller	<input type="checkbox"/> Yes	<input type="checkbox"/> No
Communication protocol	<input type="checkbox"/> Yes	<input type="checkbox"/> No
Heater/cooler (pump head)	<input type="checkbox"/> Yes	<input type="checkbox"/> No
Operation time	<input type="checkbox"/> Continuous (24h/7d)	<input type="checkbox"/> Intermittent (8h/5d)
Service & Installation	<input type="checkbox"/> Inhouse	<input type="checkbox"/> External
Constant pressure mode	<input type="checkbox"/> Yes	<input type="checkbox"/> No
Control	<input type="checkbox"/> Manual (standalone)	<input type="checkbox"/> Analog
	<input type="checkbox"/> Ethernet	<input type="checkbox"/> Mobile Control
	<input type="checkbox"/> RS-232	

ADDITIONAL REQUIREMENTS:



Request a quote online:
www.knauer.net/en/Systems-Solutions/Pumps/Request-a-quote

Overview

High-pressure dosing pumps

Precise dosing for laboratory and production

KNAUER dosing pumps are highly accurate two-piston pumps for applications in the chemical and pharmaceutical industries as well as in research and method development. They pump and dose aqueous and organic liquids, aggressive media or liquid gases. The metering pumps impress with their high chemical resistance, excellent flow rate precision and low pulsation of the pumped medium in a wide range of applications:

- Flow rates from 0.01 ml/min to 1000 ml/min
- High pressure range up to 650 bar
- Wide temperature range from -10 °C to 120 °C
- Viscous liquids up to 1000 mPa s
- Special features on request



KNAUER dosing pumps are integrated easily in your dosing application due to an independent control via display or touchscreen.

To choose the right pump type, the following aspects must be considered:



**FLOW AND
PRESSURE RANGE**



**CHEMICAL
COMPATIBILITY**



CONNECTIVITY



**MASS FLOW
CONTROL**

Application areas

- Chemical engineering
- Pharmacy
- Process engineering
- Research & Development

Application examples

- Flow chemistry
- Polymer production
- Microfluidics
- Dosing of aggressive or radioactive substances



Flow-pressure range

Choose the right dosing pump for your application easily

When choosing a dosing system, flow rate and pressure range are key parameters. KNAUER dosing pumps are designed for HPLC applications and thus feature excellent pressure stability, low pulsation and precise delivery at flow rates from 0.01 - 1000 ml/min.

AZURA® Pump P 2.1S / P 4.1S For flow rates of up to 50 ml/min

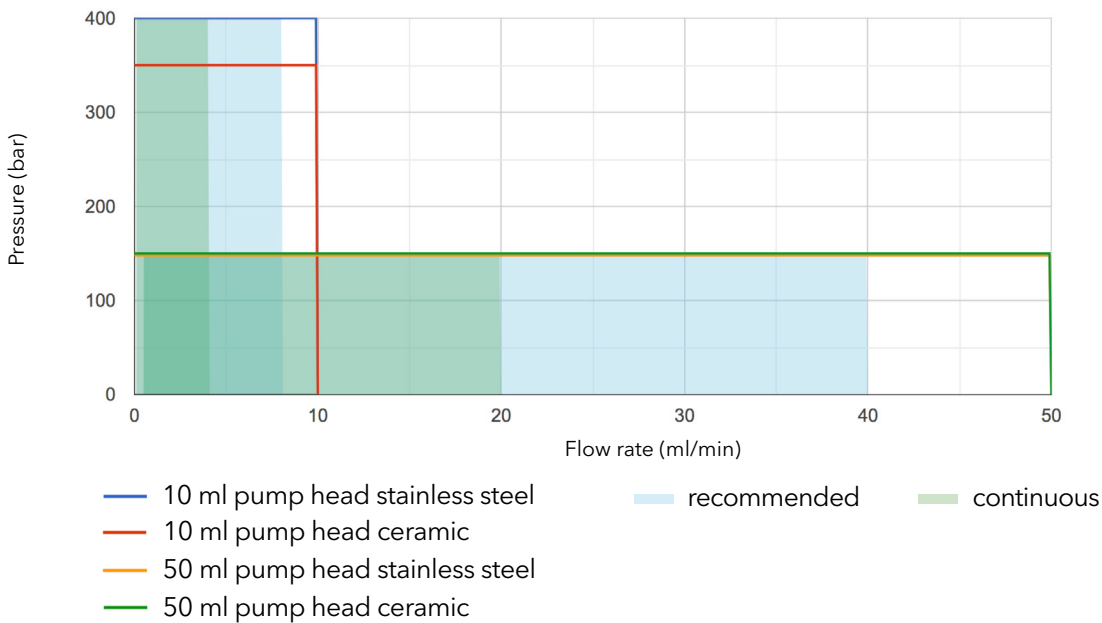

BlueShadow Pump 40P Compact solution for flow rates of up to 50 ml/min

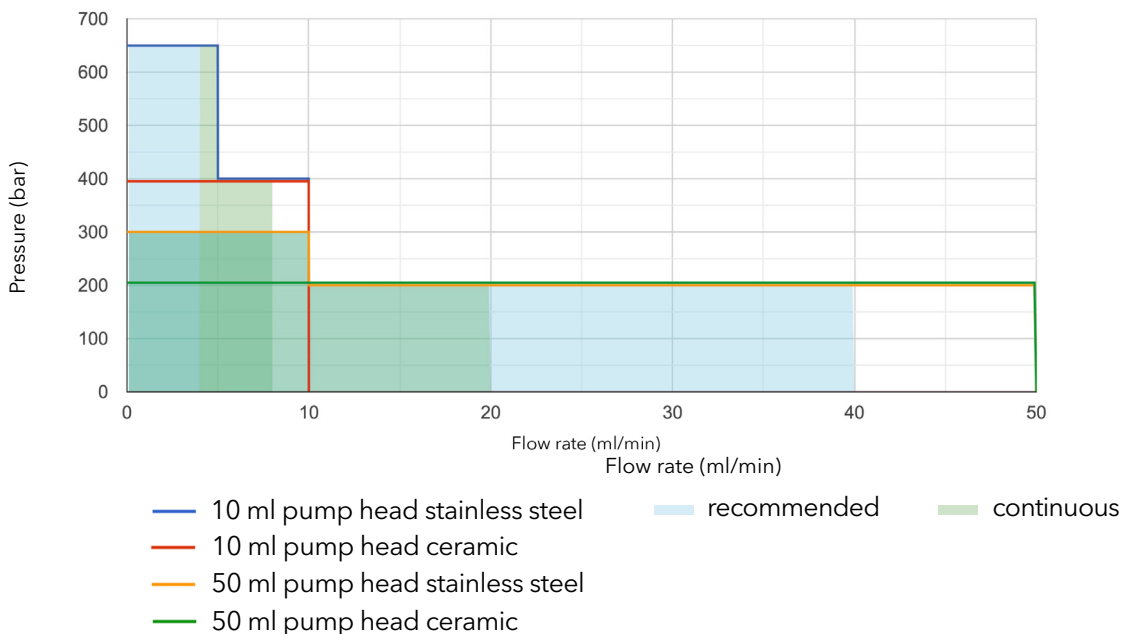

BlueShadow Pump 80P For flow rates of up to 1000 ml/min

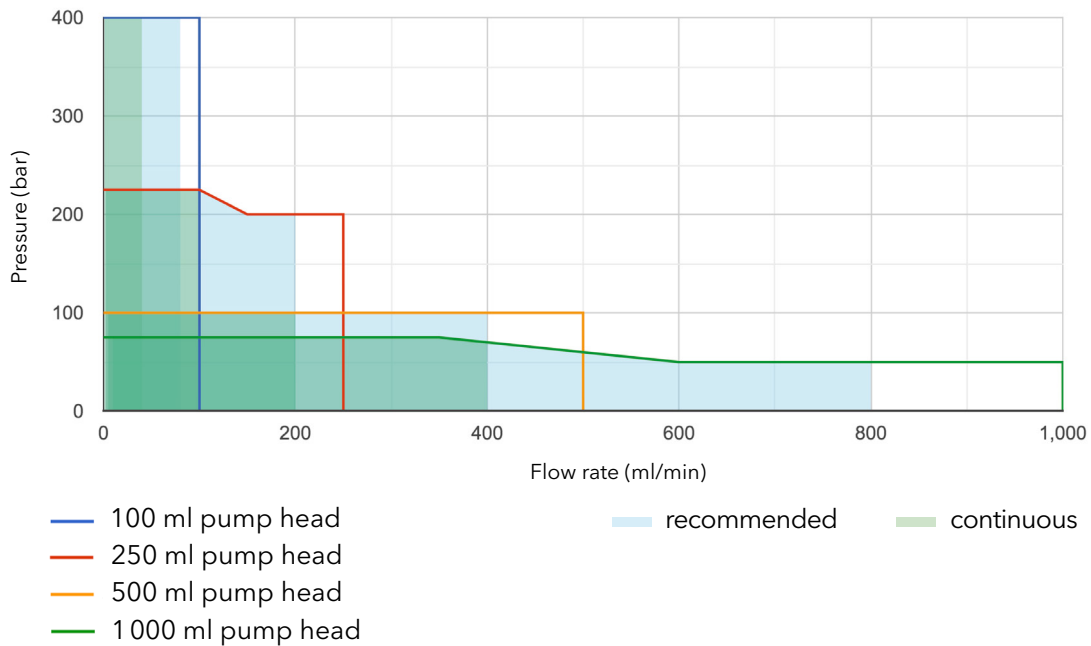

Chemical compatibility

In order to adapt the dosing solution to your tasks, the wetted materials must be perfectly matched to the application. KNAUER dosing pumps are resistant to a wide range of chemicals. Depending on the pumped medium, the wetted materials can be stainless steel, Hastelloy C, titanium or ceramic. A choice of check valves, seals and piston rods for various types of eluents is available.

Thanks to the replaceable pump head the metering pumps can be adapted to new tasks. The documentation of operating hours is simplified by the automatic recording of the running time and maintenance cycles can be easily planned.

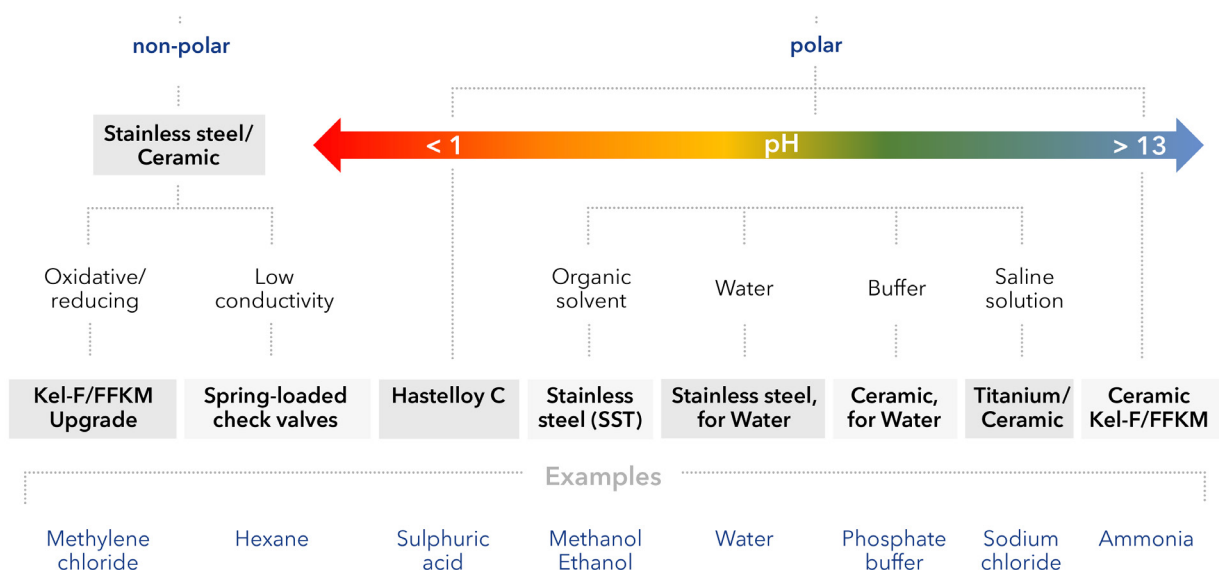

Pump control

KNAUER dosing pumps offer a wide range of control options. Configuration and adjustment of the flow rate can be made via keyboard and display. Smaller test arrangements for setting a constant flow rate can be realized quickly and easily.

In addition, all KNAUER metering pumps can be remote controlled via various interfaces. A flow rate can be set via the local network (LAN) using suitable software. Control via a serial RS-232 interface is also possible. KNAUER dosing pumps also offer a wide range of possibilities for control via an analog signal. This allows the operator to easily control the pump with an SPS or process control systems (Siemens SIMATIC).

KNAUER pumps can be controlled with a wide range of software solutions. The hand-held Mobile Control allows device monitoring with a touch-optimized user interface. Drivers for chromatography data systems (**ClarityChrom®**, **PurityChrom®**, **OpenLab CDS EZChrom Edition**) are available.

If you want to integrate KNAUER devices into a specific process control system, we can provide the communication protocol of our pumps free of charge.



Accurate dosing for demanding applications

Gain flexibility, improve precision



In combination with Coriolis Mass Flow Controllers, KNAUER dosing pumps can be operated at flow rate accuracies of 0.5 % or better.

Continuous monitoring is a main requirement in process industry and pharmaceutical production.

When combining a KNAUER dosing pump with a mass flow controller, the pump receives an analog control signal from the built-in PID controller of the flowmeter.

The operator has full control over the metering process via the supplied software solution. From fine-tuning of the control parameters to batch dosing and automated filling limits, the tandem of pump and flowmeter opens up a whole range of possibilities.

Let us know your dosing challenge and we will find the perfect solution for you.

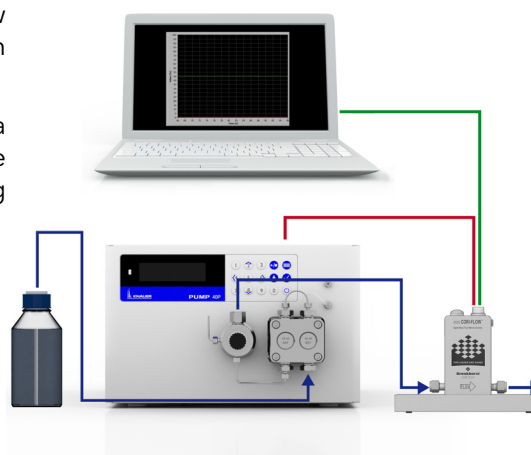

Temperature control

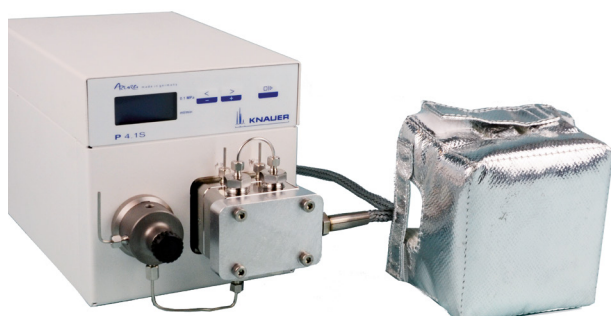

Constant fluid temperature is a key factor for many applications. Pump head heating facilitates dosing of viscous liquids, while pump head cooling prevents evaporation of liquid gases.

All KNAUER pumps can be operated at liquid temperatures of up to 60 °C.

To avoid temperature gradients, the pump heads can be equipped with temperature control. Choose between an electrical heating solution and a heat exchanger in combination with a thermostat.



Pre-heating the liquid before it enters the pump is a common practise when working with viscous substances. KNAUER offers a solvent heater for these applications to minimize temperature gradients and ensure optimal process conditions.

High-temperature dosing

The BlueShadow Pump 40P series features a 10 and 50 ml pump head for liquid temperatures of up to 120 °C. The thermally decoupled pump head contains a ceramic backplate, which decreases heat transmission to the pump drive. The pump is available with and without automatic piston seal wash.

Regulated environments

KNAUER dosing pumps can be used in regulated environments. We offer material documentation of wetted parts (see page 28) as well as factory and site acceptance tests (FAT/SAT).

Do you work in a regulated environment?
Do not hesitate to contact our sales team!



BlueShadow Pump 40P

The BlueShadow Pump 40P was designed to provide exceptionally precise and reliable solvent delivery for a wide range of dosing applications. Exchangeable pump heads with maximum flow rates of 10 and 50 ml/min cover a wide range of high-pressure dosing tasks. Practically pulse-free flow is achieved by our enhanced smart drive control which actively prevents pressure ripple instead of just dampening it. The improved design features a built-in inline filter and low dead volume fluidic path. Change your metering rate with the wipeable membrane keyboard or use the remote control from your process control system.

Pump heads for high-temperature applications enable solvent delivery at up to 120°C. Minimize temperature gradients by adding a pump head heater and insulation sleeve.



Specifications

Solvent delivery

Pump type	High-Pressure Dosing Pump
Delivery system	Dual piston pump with one working piston, one auxillary piston
Pulsation compensation	Active Pulsation Compensation
Piston seal washing	Active Wash
Flow rate accuracy	± 0.25 % (measured at 5-80 % of flow range, using ethanol)
Flow rate precision	≤ 0.04 % RSD or 0.008 min SD (whichever is greater)
Pulsation	< 2 % amplitude (typically < 1.3 %) or < 0.3 MPa (3 bar), whatever is greater, at 1 ml/min ethanol, at all pressures > 1 MPa (10 bar, 147 psi).
System protection	Pmin und Pmax adjustable
Liquid temperature range	4–60 °C (39.2–140 °F)
Leak management	No
Pump head inlet (standard)	1/8" OD, 2.1 mm ID FEP tubing (UNF 1/4-28 Thread, flat bottom)
Pump head outlet (standard)	UNF 10-32 Thread (for 1/16" capillary)

Communication

Display	Yes
Inputs	LAN, RS-232, Pin header connectors (Analog IN, Start In, Error IN)
Analog inputs	Flow rate, 0 - 10 V via pin header connectors
Analog control input	Flow Rate
Level/event outputs	8 event outputs (TTL, OC, Relais) and 24 V
Control	Standalone, LAN, RS-232, Analog and event control
Programming	10 programs, 9 program links + wake up program, supports gradients

Technical parameters

Leak sensor	No
Special features	Pump Head is detected automatically using radio frequency indentificaion (RFID), Inline filter
GLP	RFID pump head recognition, detailed report
Conformity	IP20 ingress protection
Display	LCD Display
Ambient conditions	4 - 40 °C (50-104 °F), Air humidity below 90 %, non-condensing

General

Power supply	100 - 240 V; 50 - 60 Hz; Maximum power consumption 320 Watt
Dimensions	242 mm x 165 mm x 399 mm (W x H x D)
Weight	6.1 kg
Optional accessories	High temperature pump head, pump head heating and cooling device



For accessories see page 25.



A variety of software control options is available: KNAUER offers various options for drivers. For more information, please visit <https://www.knauer.net/softwarecontrol>

BlueShadow Pump 40P with 10 ml pump head

Specifications

Pump specifications	
Pump head	10 ml
Flow rate range	0.001 - 10 ml/min
Maximum delivery pressure	9430 psi / 650 bar / 65 MPa up to 5 ml/min; 5800 psi / 400 bar / 40 MPa up to 10 ml/min
Wetted materials	Stainless steel version: GFP (graphite fiber reinforced PTFE), sapphire, ruby, PEEK, stainless steel, Zirconium oxide Ceramic version: GFP (graphite fiber reinforced PTFE), sapphire, ruby, PEEK, Zirconium oxide, aluminium oxide
Maximum viscosity	100 mPa s
Flow rate increment	0.001 ml/min
Best working conditions	0.1 - 8.0 ml/min
Continuous working conditions	0.1 -4.0 ml/min
Pumphead material	Stainless steel / ceramic

Ordering details:

APC40EA	BlueShadow Pump 40P with 10 ml/min stainless steel pump head
APC40EE	BlueShadow Pump 40P with 10 ml/min stainless steel pump head, high-temperature version (Tmax=120° C)
APC40EI	BlueShadow Pump 40P with 10 ml/min stainless steel pump head, high-temperature version (Tmax=120° C), with piston seal wash
APC60EB	BlueShadow Pump 40P with 10 ml pump head, ceramic (metal-free)

BlueShadow Pump 40P with 50 ml pump head

Specifications

Pump specifications	
Pump head	50 ml
Flow rate range	0.001 - 50 ml/min
Maximum delivery pressure	4350 psi / 300 bar / 30 MPa up to 10 ml/min; 2900 psi / 200 bar / 20 MPa up to 50 ml/min
Wetted materials	Stainless steel version: GFP (graphite fiber reinforced PTFE), sapphire, ruby, PEEK, Zirconium oxide Ceramic version: GFP (graphite fiber reinforced PTFE), sapphire, ruby, aluminium oxide, Zirconium oxide
Maximum viscosity	100 mPa s
Flow rate increment	0.001 ml/min
Best working conditions	0.1 - 40 ml/min
Continuous working conditions	0.1 - 20 ml/min
Pumphead material	Stainless steel / ceramic

Ordering details:

APC40FA	BlueShadow Pump 40P with 50 ml/min stainless steel pump head
APC60FB	BlueShadow Pump 40P with 50 ml/min ceramic pump head
APC40FE	BlueShadow Pump 40P with 50 ml/min stainless steel pump head, high-temperature version (Tmax=120° C)
APC40FH	BlueShadow Pump 40P with 50 ml/min stainless steel pump head, high-temperature version (Tmax=120° C), with piston seal wash

BlueShadow Pump 80P

The BlueShadow Pump 80P delivers stable and precise solvent flow for your dosing application. Available in stainless steel or biocompatible titanium versions, the pump heads enable a wide range of applications. The integrated automatic recognition of the pump head with RFID technology allows the fast adaption of the pump. Change from low-flow organic solvent delivery to high-flow biocompatible buffer metering with minimum downtime.

By adding one or more additional pumps, binary, ternary or even quaternary high-pressure mixing gradient systems can be easily configured. The pump can also be equipped with a binary or ternary gradient valve block to configure cost-effective low-pressure gradient mixing systems. Exchangeable pump heads for flow rates up to 1 000 ml/min and pressures up to 40 MPa make it possible to easily adapt the pump to changing performance requirements and allow simple maintenance.



Specifications

Solvent delivery

Pump type	High-Pressure Dosing Pump
Delivery system	Dual Piston Pump with two working pistons
Pulsation compensation	Active Pulsation Compensation
Piston seal washing	Active Wash
Flow rate accuracy	± 2 % (measured at 5 - 50 % of the flow range using ethanol/water 10:90)
Flow rate precision	< 0.1 % RSD, measured at 5 - 50 % of the flow range using ethanol/water 10:90
System protection	Pmin und Pmax adjustable
Gradient range	0 - 100 % (with optional LPG valve block)
Gradient formation	LPG (with optional LPG valve block) or HPG
Liquid temperature range	4–60 °C (39.2–140 °F)
Pump head inlet (standard)	M8 x 1 (flat bottom)
Pump head outlet (standard)	M8 x 1 (coned)

Communication

Display	LCD Display
Inputs	LAN, RS-232, Pin header connectors (Analog IN, Start In, Error IN)
Analog inputs	Flow rate, 0 - 10 V via pin header connectors
Analog control input	Flow Rate
Level/event outputs	8 event outputs (TTL, OC, Relais) and 24 V
Control	Standalone, LAN, RS-232, Analog and event control
Programming	19 programs, 10 program links (Links), 1 WAKE UP program (Program 20)

Technical parameters

Special features	Pump Head is detected automatically using radio frequency identification (RFID)
Conformity	IP20 ingress protection
Ambient conditions	4 - 40 °C (50-104 °F), Air humidity below 90 %, non-condensing

General

Power supply	100 - 240 V; 50 - 60 Hz; Maximum power consumption 320 Watt
Dimensions	242 x 191 mm x 407 mm (W x H x D)
Weight	13.2 kg
Optional accessories	Ternary low pressure gradient (LPG) valve block (10 - 220 ml/min), binary LPG valve block (10 - 800 ml/min), pump head heating and cooling device, mixer



For accessories see page 25.



A variety of software control options is available: KNAUER offers various options for drivers. For more information, please visit <https://www.knauer.net/softwarecontrol>

BlueShadow Pump 80P with 100 ml pump head

Specifications

Pump specifications

Pump head	100 ml
Flow rate range	0.01 - 100 ml/min
Maximum delivery pressure	5800 psi / 400 bar / 40 MPa
Wetted materials	Stainless steel version: FFKM, GFP (graphite fiber reinforced PTFE), ruby, sapphire, PEEK, stainless steel, Zirconium oxide Titanium version: GFP (graphite fiber reinforced PTFE), ruby, sapphire, Titanium, FFKM, aluminium oxide, PEEK, Zirconium oxide
Maximum viscosity	1000 mPa s
Flow rate increment	0.01 ml/min
Best working conditions	1 - 80 ml/min
Continuous working conditions	1 - 40 ml/min
Pump head inlet (standard)	4 mm OD, 3 mm ID PTFE tubing, (M8x1 flat bottom)
Pump head outlet (standard)	Stainless steel: 1/8" (M8x1, coned) Titanium: 1/8" (UNF 1/4-28, coned)
Pumphead material	Stainless steel / Titanium

Ordering details:

APD30KA	BlueShadow Pump 80P with 100 ml pump head (stainless steel)
APD60KB	BlueShadow Pump 80P with 100 ml pump head (titanium)

BlueShadow Pump 80P with 250 ml pump head

Specifications

Pump specifications

Pump head	250 ml
Flow rate range	0.01 - 250 ml/min
Maximum delivery pressure	3260 psi / 225 bar / 22.5 MPa up to 100 ml/min, 2900 psi / 200 bar / 20 MPa up to 250 ml/min
Wetted materials	Stainless steel version: FFKM, GFP (graphite fiber reinforced PTFE), PEEK, ruby, sapphire, stainless steel, Zirconium oxide Titanium version: GFP (graphite fiber reinforced PTFE), ruby, sapphire, Titanium, FFKM, aluminium oxide, PEEK, Zirconium oxide
Maximum viscosity	1000 mPa s
Flow rate increment	0.1 ml/min
Best working conditions	2.5 - 200 ml/min
Continuous working conditions	2.5 - 100 ml/min
Pump head inlet (standard)	4 mm OD, 3 mm ID PTFE tubing, (M8x1 flat bottom)
Pump head outlet (standard)	Stainless steel: 1/8" (M8x1, coned) Titanium: 1/8" (UNF 1/4-28, coned)
Pumphead material	Stainless steel / Titanium

Ordering details:

APD30LA	BlueShadow Pump 80P with 250 ml pump head (stainless steel)
APD60LC	BlueShadow Pump 80P with 250 ml pump head (titanium)

BlueShadow Pump 80P with 500 ml pump head

Specifications

Pump specifications	
Pump head	500 ml
Flow rate range	0.01 - 500 ml/min
Maximum delivery pressure	1450 psi / 100 bar / 10 MPa
Wetted materials	Stainless steel version: FFKM, GFP (graphite fiber reinforced PTFE), PEEK, ruby, sapphire, stainless steel, Zirconium oxide Titanium version: GFP (graphite fiber reinforced PTFE), ruby, sapphire, Titanium, FFKM, aluminium oxide, PEEK, Zirconium oxide
Maximum viscosity	1000 mPa s
Flow rate increment	0.1 ml/min
Best working conditions	5 - 400 ml/min
Continuous working conditions	5 - 200 ml/min
Pump head inlet (standard)	4 mm OD, 3 mm ID PTFE tubing, (M8x1 flat bottom)
Pump head outlet (standard)	Stainless steel: 1/8" (M8x1, coned) Titanium: 1/8" (UNF 1/4-28, coned)
Pumphead material	Stainless steel / Titanium

Ordering details:

APD30MA	BlueShadow Pump 80P with 500 ml pump head (stainless steel)
APD60MC	BlueShadow Pump 80P with 500 ml pump head (titanium)

BlueShadow Pump 80P with 1000 ml pump head

Specifications

Pump specifications	
Pump head	1000 ml
Flow rate range	1 - 1000 ml/min
Maximum delivery pressure	1087 psi / 75 bar / 7.5 MPa to 350 ml/min, linear reduction: 75-50 bar of 350-600 ml/min, 725 psi / 50 bar / 5 MPa up to 1000 ml/min
Wetted materials	Stainless steel version: FFKM, GFP (graphite fiber reinforced PTFE), PEEK, ruby, sapphire, stainless steel, Zirconium oxide Titanium version: FFKM, GFP (graphite fiber reinforced PTFE), ruby, sapphire, Titanium, aluminium oxide, PEEK, Zirconium oxide
Maximum viscosity	1000 mPa s
Flow rate increment	0.1 ml/min
Best working conditions	10 - 800 ml/min
Continuous working conditions	10 - 400 ml/min
Pump head inlet (standard)	9 mm OD, 7 mm ID, PTFE tubing, piped
Pump head outlet (standard)	Stainless steel: 1/8" (M8x1, coned) Titanium: 1/8" (UNF 1/4-28, coned)
Pumphead material	Stainless steel / Titanium

Ordering details:

APD30NA	BlueShadow Pump 80P with 1000 ml pump head (stainless steel)
APD60NB	BlueShadow Pump 80P with 1000 ml pump head (titanium)

AZURA® Pump P 2.1S

AZURA® Pump P 2.1S was developed for high-pressure dosing applications of up to 400 bar and for flow rates of up to 50 ml/min. Whenever a compact and the easy-to-integrate pump is required, this pump is a perfect choice. The exchangeable pump heads are compatible with a wide range of chemicals and the versatile control options allow easy remote and standalone operation. For aggressive liquids, a Hastelloy® C version is available.



Specifications

Solvent delivery

Pump type	Ultra-compact high-pressure pump
Delivery system	Dual piston pump with one working piston, one auxillary piston
Pulsation compensation	No
Piston seal washing	Passive Wash
Flow rate accuracy	± 5 %, measured at 5 - 50 % of flow range using ethanol/water 10:90, ±2 % at calibration point (one point calibration), measured at 5 - 50 % of flow range
Flow rate precision	≤ 0.5 % RSD, measured at 1/5 ml/min using ethanol/water 10:90
System protection	Imin und Imax are programmable (I ~ pressure)
Liquid temperature range	4–60 °C (39.2–140 °F)
Pump head inlet (standard)	1/8" OD, 2.1 mm ID FEP tubing (UNF 1/4-28 thread, flat bottom)
Pump head outlet (standard)	UNF 10-32 Thread (for 1/16" capillary)

Communication

Display	Yes
Inputs	LAN, Pin header connectors (Analog IN, Start In, Error IN), RS-232
Analog inputs	0 - 10 V
Analog control input	Flow rate
Control	LAN, RS-232, analog, standalone

Technical parameters

Display	Yes
Ambient conditions	10-40 °C (50-104 °F) Air humidity below 90 %, non-condensing

General

Power supply	100 - 240 V; 50 - 60 Hz; Maximum power consumption 100 Watt
Dimensions	121 x 129 x 220 mm (W x H x D)
Weight	2.3 kg



For accessories see page 25.



A variety of software control options is available: KNAUER offers various options for drivers. For more information, please visit <https://www.knauer.net/softwarecontrol>

AZURA® Pump P 2.1S with 10 ml pump head

Specifications

Pump specifications	
Pump head	10 ml
Flow rate range	0.001 - 10 ml/min
Maximum delivery pressure	5800 psi / 400 bar / 40 MPa up to 10 ml/min
Wetted materials	Stainless steel version: Zirconium oxide, stainless steel, sapphire, ruby, GFP (graphite fiber reinforced PTFE), FKM, aluminium oxide Ceramic version: GFP (graphite fiber reinforced PTFE), ruby, sapphire, aluminium oxide, ceramic, FKM, PEEK, Zirconium oxide Hastelloy® C version: FFKM, GFP (graphite fiber reinforced PTFE), sapphire, aluminium oxide, Hastelloy® C, KEL-F® (PCTFE), ruby, Zirconium oxide
Maximum viscosity	100 MPa s (at reduced max. flow)
Flow rate increment	0.001 ml/min
Best working conditions	0.1 - 8.0 ml/min
Continuous working conditions	0.1 - 4.0 ml/min
Pumphead material	Stainless steel / ceramic / Hastelloy® C

Ordering details:

APG90EA	AZURA® Pump P 2.1S compact HPLC pump with 10 ml/min stainless steel pump head
APG90EB	AZURA® Pump P 2.1S compact HPLC pump with 10 ml/min ceramic pump head
APG90EC	AZURA® Pump P 2.1S compact HPLC pump with 10 ml/min Hastelloy® C pump head
APG90EG	AZURA® Pump P 2.1S compact HPLC pump with 10 ml/min stainless steel pump head, recommended for aqueous solutions

AZURA® Pump P 2.1S with 50 ml pump head

Specifications

Pump specifications	
Pump head	50 ml
Flow rate range	0.01 - 50 ml/min
Maximum delivery pressure	2180 psi / 150 bar / 15 MPa up to 50 ml/min
Wetted materials	Stainless steel version: GFP (graphite fiber reinforced PTFE), sapphire, aluminium oxide, ceramic, FKM, PEEK, ruby, Titanium, Zirconium oxide Ceramic version: GFP (graphite fiber reinforced PTFE), ruby, sapphire, aluminium oxide, ceramic, FKM, PEEK, Zirconium oxide Hastelloy® C version: FFKM, GFP (graphite fiber reinforced PTFE), sapphire, ruby, Zirconium oxide, Hastelloy® C, KEL-F® (PCTFE)
Maximum viscosity	100 mPa s (at reduced max. flow)
Flow rate increment	0.01 ml/min
Best working conditions	0.5 - 40.0 ml/min
Continuous working conditions	0.5 - 20 ml/min
Pumphead material	Stainless steel / ceramic / Hastelloy® C

Ordering details:

APG90FA	AZURA® Pump P 2.1S compact HPLC pump with 50 ml/min stainless steel pump head
APG90FB	AZURA® Pump P 2.1S compact HPLC pump with 50 ml/min ceramic pump head
APG90FC	AZURA® Pump P 2.1S compact HPLC pump with 50 ml/min Hastelloy® C pump head
APG90FG	AZURA® Pump P 2.1S compact HPLC pump with 50 ml/min stainless steel pump head, recommended for aqueous solutions

AZURA® Pump P 4.1S

AZURA® Pump P 4.1S was developed for high-pressure dosing applications of up to 400 bar and for flow rates of up to 50 ml/min. Whenever a compact and the easy-to-integrate pump is required, this pump is a perfect choice. The pump contains a manual purge valve with a built-in pressure sensor. The pump automatically stops the flow when minimum or maximum pressure limits are reached. The exchangeable pump heads are compatible with a wide range of chemicals and the versatile control options allow easy remote and standalone operation.



Specifications

Solvent delivery

Pump type	Ultra-compact high-pressure pump
Delivery system	Dual piston pump with one working piston, one auxiliary piston
Pulsation compensation	No
Piston seal washing	Passive Wash
Flow rate accuracy	± 2 %, measured at 5 - 50 % of flow range using ethanol/water 10:90
Flow rate precision	≤ 0.5 % RSD, measured at 1/5 ml/min using ethanol/water 10:90
System protection	Pmin und Pmax are programmable
Liquid temperature range	4–60 °C (39.2–140 °F)
Pump head inlet (standard)	1/8" OD, 2.1 mm ID FEP tubing (UNF 1/4-28 thread, flat bottom)
Pump head outlet (standard)	UNF 10-32 Thread (for 1/16" capillary)

Communication

Display	Yes
Inputs	LAN, Pin header connectors (Analog IN, Start In, Error IN), RS-232
Analog inputs	0 - 10 V
Analog control input	Flow Rate
Control	LAN, RS-232, analog, standalone

Technical parameters

Display	Yes
Ambient conditions	10-40 °C (50-104 °F) Air humidity below 90 %, non-condensing

General

Power supply	100 - 240 V; 50 - 60 Hz; Maximum power consumption 100 Watt
Dimensions	121 x 129 x 220 mm (W x H x D)
Weight	2.4 kg



For accessories
see page 25.



A variety of software control options is available: KNAUER offers various options for drivers. For more information, please visit <https://www.knauer.net/softwarecontrol>

AZURA® Pump P 4.1S with 10 ml pump head

Specifications

Pump specifications	
Pump head	10 ml
Flow rate range	0.001 - 10 ml/min
Maximum delivery pressure	5800 psi / 400 bar / 40 MPa up to 10 ml/min
Wetted materials	Stainless steel version: GFP (graphite fiber reinforced PTFE), ruby, sapphire, Titanium, PEEK Ceramic version: GFP (graphite fiber reinforced PTFE), Titanium, ruby, sapphire, ceramic, FKM Titanium version: GFP (graphite fiber reinforced PTFE), Titanium, ruby, sapphire, aluminium oxide, ceramic, FKM, PEEK, Zirconium oxide
Maximum viscosity	100 mPa s (at reduced max. flow)
Flow rate increment	0.001 ml/min
Best working conditions	0.1 - 8.0 ml/min
Continuous working conditions	0.1 - 4.0 ml/min
Pumphead material	Stainless steel / ceramic / Hastelloy® C

Ordering details:

APG20EA	AZURA® Pump P 4.1S compact HPLC pump with 10 ml/min stainless steel pump head, stainless steel connections
APG20EB	AZURA® Pump P 4.1S compact HPLC pump with 10 ml/min ceramic pump head, PEEK connections
APG20EC	AZURA® Pump P 4.1S compact HPLC pump with 10 ml/min Hastelloy® C pump head, Titanium pressure sensor, Hastelloy® C connections
APG20EF	AZURA® Pump P 4.1S compact HPLC pump with 10 ml/min ceramic pump head, Ti connections.
APG20EG	AZURA® Pump P 4.1S compact HPLC pump with 10 ml/min stainless steel pump head, stainless steel connections, recommended for aqueous solutions
APG20EH	AZURA® Pump P 4.1S compact HPLC pump with 10 ml/min ceramic pump head, Titanium connections, recommended for aqueous solutions

AZURA® Pump P 4.1S with 50 ml pump head

Specifications

Pump specifications	
Pump head	50 ml
Flow rate range	0.01 - 50 ml/min
Maximum delivery pressure	2180 psi / 150 bar / 15 MPa up to 50 ml/min
Wetted materials	Stainless steel version: GFP (graphite fiber reinforced PTFE), ruby, sapphire, Titanium Ceramic version: GFP (graphite fiber reinforced PTFE), Titanium, sapphire, ruby, aluminium oxide, ceramic, FKM, PEEK, Zirconium oxide Titanium version: GFP (graphite fiber reinforced PTFE), Titanium, FFKM, sapphire, aluminium oxide, Hastelloy® C, KEL-F® (PCTFE), PEEK, ruby, Zirconium oxide
Maximum viscosity	100 mPa s (at reduced max. flow)
Flow rate increment	0.01 ml/min
Best working conditions	0.5 - 40.0 ml/min
Continuous working conditions	0.5 - 20 ml/min
Pumphead material	Stainless steel / ceramic / Hastelloy® C

Ordering details:

APG20FA	AZURA® Pump P 4.1S compact HPLC pump with 50 ml/min stainless steel pump head, stainless steel connections
APG20FB	AZURA® Pump P 4.1S compact HPLC pump with 50 ml/min ceramic pump head, PEEK connections
APG20FC	AZURA® Pump P 4.1S compact HPLC pump with 50 ml/min Hastelloy® C pump head, Hastelloy® C connections
APG20FG	AZURA® Pump P 4.1S compact HPLC pump with 50 ml/min stainless steel pump head, stainless steel connections, recommended for aqueous solutions
APG20FI	AZURA® Pump P 4.1S compact HPLC pump with 50 ml/min ceramic pump head, PEEK connections, recommended for aqueous solutions

Mass flow controllers

Mini CORI-Flow are precise and compact mass flow controllers, based on the Coriolis measuring principle. Coriolis flowmeters are unmatched in accuracy. When applied for liquids, the mass flow accuracy is better than $\pm 0.2\%$ of the measured flow rate.

Instruments of the mini CORI-Flow series contain a uniquely shaped, single-loop sensor tube, forming part of an oscillating system. When a fluid flows through the tube, Coriolis forces cause a variable phase shift, which is detected by sensors and fed into the integrally mounted pc-board. The resulting output signal is strictly proportional to the real mass flow rate. The mini CORI-Flow features density and temperature of the fluid as secondary outputs. All parameters are recorded with the included data acquisition and control software. The software allows full control over the PID parameters and a whole range of automation features (batch dosing, min/max alarms, automatic setpoint change).



Sample configuration with display (optional)

Advantages of mass flow controlled systems:

- Precise metering regardless of the density and temperature of the liquid
- No calibration required when changing liquids
- Volume logging incl. signal
- Dosing of predefined volumes (Batch dosing)

Specifications

Type	Flowmeter
Max. flow rate	0.03 - 1.66 ml/min (M12) / 1 - 50 ml/min (M13) / 2 - 833 ml/min (M14)
Maximum pressure	200 bar (50-70°C) / 350 bar (<50°C)
Flow rate range	1 - 50 ml/min
Flow rate accuracy	$\pm 0.2\%$ of rate *
Flow rate precision	$\pm 0.05\%$ of rate
Capillary connection	1/8" compression fitting (Swagelok®)
Wetted materials	stainless steel AISI 316 or equivalent optional Hastelloy-C22

Communication

Outputs	0 - 5 (10) Vdc or 0 (4) - 20 mA
Control	Standard: RS-232 (8-pin DIN male connection) Profibus-DP® bus: (5-pin M12 female; power 8-pin DIN male) DeviceNet™ Modbus-RTU; LonWorks Flow bus (5-pin M12 male)

Technical parameters

Special features	Additional: Profibus interface
Conformity	IP 65 (weatherproof)
Display	Available

General

Power supply	+15-24 V DC $\pm 10\%$ max. ripple recommended: 50 mV tt
Weight	Meter: 1.2 kg; Controller: 1.7 kg

* optimal accuracy will be reached after approx. 30 minutes after instrument power up

Ordering details:

Device	
A5390	Mini CORI-Flow (M13) Mass flow controller incl. mounting block, Flow: 1 - 50 ml/min, stainless steel 316
A5391	Mini CORI-Flow (M14) Mass flow controller incl. mounting block, Flow: 2 - 833 ml/min, stainless steel 316
A5391P	Mini CORI-Flow (M14) Mass flow controller incl. mounting block, Flow: 2 - 833 ml/min, stainless steel 316, Profibus
A5393	Mini CORI-Flow (M13) Mass flow controller incl. mounting block, Flow: 1 - 50 ml/min, stainless steel 316, Profibus
A5394	Mini CORI-Flow (M12) Mass flow controller incl. mounting block, Flow: 0.03 - 3.3 ml/min, stainless steel 316
A5395	Mini CORI-Flow (M13) Mass flow controller incl. mounting block, Flow: 1 - 50 ml/min, Hastelloy-C22
A5398	Mini CORI-Flow (M140) Mass flow controller, Flow: 2 - 833 ml/min, stainless steel 316, Profinet
A5396	HI-TEC Bright display for Mini CORI-Flow mass flow controller (display, setpoint and counter)



BlueShadow Detector 40D

The BlueShadow detector 40D is a competitively priced HPLC spectrophotometer for routine HPLC applications including fast LC methods. Besides offering excellent technical specifications, this robust detector features a highly flexible and compact design. The BlueShadow Detector 40D comes with an installed deuterium lamp which covers a wavelength range from 190 to 750 nm.

This detector can be controlled with ClarityChrom® software, as well as from the keypad (stand-alone operation), via LAN, via RS-232, or through analog input/output. Due to a smart design the flow cell is easily accessible and can be changed very quickly. You can choose between a wide range of flow cells for analytical or preparative LC applications with flow rates from 10 µl/min up to 10 l/min.



Specifications

Detection

Detector type	Variable single wavelength UV detector
Detection channels	1
Light source	Deuterium (D ₂) lamp with integrated GLP chip
Wavelength range	190 - 750 nm
Spectral bandwidth	11 nm at H _α line (FWHM)
Wavelength accuracy	± 2.5 nm
Wavelength precision	0.3 nm (ASTM E275-93)
Noise	± 15 µAU at 254 nm (ASTM E1657-98)
Drift	300 µAU/h at 254 nm (ASTM E1657-98)
Linearity	> 2.0 AU at 270 nm (ASTM E1657-98)
Maximum data rate	50 Hz (LAN)/20 Hz (Analog)/10 Hz (RS-232)
Flow cell	Not included
Time constants	0.1 / 0.2 / 0.5 / 1.0 / 2.0 / 5.0 / 10.0 s
Integration time	Automatic

Communication

Inputs	Error (IN), Start (IN), Autozero, 0 - 10 V Analog IN
Outputs	Events 1 - 3, + 5 V, 24 V Valve
Analog outputs	1 x 0 - 5 V scalable, 20 bit, offset adjustable
Control	Digital: LAN-DHCP, RS-232, remote connector/Analog: wavelength control/Manual: keypad
Programming	Timed: wavelength, events, fraction valve, links, wake up (program, link); /9 programs, 50 program lines

Technical parameters

GLP	Detailed report including lamp recognition, operating hours, /lamp operating hours, number of lamp ignitions
Display	Matrix display with keypad
Ambient conditions	Temperature range: 4 - 40 °C; 39.2 - 104 °F, Humidity: below 90 % non condensing

General

Power supply	100 - 240 V, 50 - 60 Hz, 75 W
Dimensions	242 x 169 x 399 mm (W x H x D)
Weight	5.3 kg

Ordering details:

Device

ADI01	190 - 750 nm, variable single wavelength UV/VIS detector
ADI04	190 - 750 nm, variable single wavelength UV/VIS detector with fiber optic connectors



For accessories see page 29.



A variety of software control options is available: KNAUER offers various options for drivers. For more information, please visit <https://www.knauer.net/softwarecontrol>

BlueShadow Detector 50D



The BlueShadow 50D offers high sensitivity and baseline stability for HPLC applications including fast LC methods. With its high speed scanning design, up to four different wavelengths can be monitored simultaneously while acquiring spectral data from 190 to 750 nm. Its remarkable values for noise, drift, and linearity are achieved through smart optical bench technology and the use of optimized components.

The detector comes with an installed deuterium lamp which covers a wavelength range from 190 to 750 nm. This detector can be controlled with OpenLab® EZChrom Edition, ClarityChrom® software, as well as via the integrated display (stand-alone operation), via LAN, via RS-232, or through analog input/output. Due to a smart design the flow cell is easily accessible and can be changed very quickly. A wide range of flow cells is available for practically any LC application, including micro flow cells for flow rates up to 10 µl/min and flow cells for preparative HPLC up to 10 l/min.



Specifications

Detection	
Detector type	Variable multiwavelength detector
Detection channels	4
Light source	Deuterium (D ₂) lamp with integrated GLP chip
Wavelength range	190 - 750 nm 190 - 900 nm
Spectral bandwidth	6 nm at H _α line (FWHM)
Wavelength accuracy	± 1.5 nm (verification with integrated holmium oxide filter)
Wavelength precision	0.4 nm (ASTM E275-93)
Noise	± 7.5 µAU at 254 nm (ASTM E1657-98)
Drift	200 µAU/h at 254 nm (ASTM E1657-98)
Linearity	> 2.8 AU at 270 nm (ASTM E1657-98)
Maximum data rate	50 Hz (LAN) 1 channel/20 Hz (Analog) 1 channel/10 Hz (RS-232) 1 channel
Flow cell	Not included
Time constants	0.1 / 0.2 / 0.5 / 1.0 / 2.0 / 5.0 / 10.0 s
Integration time	Automatic
Communication	
Inputs	Error (IN), Start (IN), Autozero, 0 - 10 V Analog IN
Outputs	Events 1 - 3, + 5 V, 24 V Value
Analog outputs	2 x 0 - 5 V scalable, 20 bit, offset adjustable
Control	Digital: LAN-DHCP, RS-232, remote connector/Analog: wavelength control/Manual: keypad
Programming	Timed: wavelengths, events, fraction valve, links, wake up (program, link); /9 programs, 50 program lines
Technical parameters	
GLP	Detailed report including lamp recognition, operating hours, lamp(s) operating hours, /step motor operating hours, number of lamp ignitions
Display	Matrix display with keypad
Ambient conditions	Temperature range: 4 - 40 °C; 39.2 - 104 °F, Humidity: below 90 % non condensing
General	
Power supply	100 - 240 V, 50 - 60 Hz, 75 W
Dimensions	242 x 169 x 399 mm (W x H x D)
Weight	5.3 kg

Ordering details:

Device	
ADJ01	190 - 750 nm, variable multiple wavelength UV/VIS detector
ADJ11	190 - 900 nm, variable multiple wavelength UV/VIS detector

AZURA® Valve Drive VU 4.1

The valve drive AZURA® Valve Unifier VU 4.1 enables automatic valve switching. Due to its low switching time, the flow path is blocked only for a very short time, and pressure peaks are reduced to a minimum. Valves are identified via RFID technology, which guarantees an easy valve exchange of KNAUER valves with RFID technology. This RFID technology allows to easily check GLP data, and this way to simplify maintenance such as the exchange of a rotor seal. The display enables user-friendly standalone operation. In addition, the valve drive can be operated with software as well with an optional touch display (Mobile Control), via LAN or analog input/output, by which it can be integrated into nearly every LC system.



Sample configuration

Key features

- One valve drive for all valves
- Ultra fast switching cycle
- Easy maintenance
- Compact
- Multiple interfaces and drivers available

Specifications

Communication

Interfaces	LAN, display, terminal strip
Control	Display, software, event control
Inputs	Binary control; Home, Backward/Inject, Forward/Load, Start IN
Outputs	Trigger out, Event

General

Power supply	External DC 24V, 65 W
Dimensions	80 x 123 x 192 mm (W x H x D)
Weight	1.9 kg
Ambient conditions	Temperature range: 4-40 °C; 39.2-104 °F below 90 % humidity (non condensing)

Ordering details:

AWA01XA VU 4.1 valve drive for V 4.1 valves



For accessories and valves
see page 20.



A variety of software control options is available: KNAUER offers various options for drivers. For more information, please visit <https://www.knauer.net/softwarecontrol>

Valves for valve drive VU 4.1

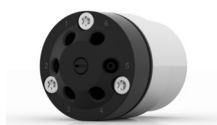

AVE25AE



AVN94CE



AVD24CE



AVC38AC

All valves are delivered with a set of bushings and ferrules for easy integration into your dosing system.

2-position valves

Ports	Stator material	Rotor material	Max. pressure [bar]	Bore size [mm]	Capillary connection	Order number
6	SST DLC ¹	POM	100	0.75	1/16" (UNF 10-32)	AVD23AF NEW
6	SST DLC	PEEK	500	0.75	1/16" (UNF 10-32)	AVD26AE
6	SST DLC ¹	Vespel	1200	0.3	1/16" (UNF 10-32)	AVC28AC
6	PEEK	PEEK	240	0.75	1/16" (UNF 10-32)	AVD24CE
6	SST DLC ¹	PEEK	300	1.5	1/8" (UNF 1/4-28, coned)	AVE25AE
6	SST DLC ¹	PEEK	300	1.5	1/8" (UNF 1/4-28, coned)	AVE25AI* NEW
6	PEEK	PEEK	100	2.0	1/8" (UNF 1/4-28, coned)	AVF23CE
8	SST DLC ¹	PEEK	500	0.75	1/16" (UNF 10-32)	AVD36AE
8	SST DLC ¹	Vespel	1200	0.3	1/16" (UNF 10-32)	AVC38AC
8	PEEK	PEEK	50	2.0	1/8" (UNF 1/4-28, coned)	AVF32CE NEW

* Special version of AVE25AE with 2-channel rotor seal instead of 3 channels.

Multiposition valves

Ports	Stator material	Rotor material	Max. pressure [bar]	Bore size [mm]	Capillary connection	Order number
2	SST DLC ¹	PEEK	200	1.5	1/8" (UNF 1/4-28 coned)	AVT84AH
6	SST DLC ¹	POM	100	0.75	1/16" (UNF 10-32)	AVS23AF NEW
6	SST DLC ¹	PEEK	500	0.75	1/16" (UNF 10-32)	AVS26AE
6	SST DLC ¹	Vespel	1200	0.3	1/16" (UNF 10-32)	AVR28AC
6	SST DLC ¹	PEEK	300	1.5	1/8" (UNF 1/4-28 coned)	AVT25AE
8	SST DLC ¹	PEEK	300	0.75	1/16" (UNF 10-32)	AVS35AE
8	SST DLC ¹	PEEK	500	0.75	1/16" (UNF 10-32)	AVS36AE
8	SST DLC ¹	Vespel	1200	0.3	1/16" (UNF 10-32)	AVR38AC
8	PEEK	PEEK	240	0.75	1/16" (UNF 10-32)	AVS34CE
8	SST DLC ¹	PEEK	300	0.75	1/16" (UNF 10-32)	AVS35AH
8	SST DLC ¹	PEEK	200	1.5	1/8" (UNF 1/4-28 coned)	AVT34AE
8	SST DLC ¹	PEEK	200	1.5	1/8" (UNF 1/4-28 coned)	AVT34AH**
8	PEEK	PEEK	50	2.0	1/8" (UNF 1/4-28, flat-bottom)	AVU32GE NEW
8	PEEK	PEEK	50	2.0	1/8" (UNF 1/4-28 coned)	AVU32CE
12	SST DLC ¹	PEEK	100	1.5	1/8" (UNF 1/4-28 coned)	AVT53AE
12	PEEK	PEEK	100	1.5	1/8" (UNF 1/4-28 coned)	AVT53CE NEW
16	SST DLC ¹	POM	100	0.75	1/16" (UNF 10-32)	AVQ63AF NEW
16	SST DLC ¹	PEEK	500	0.6	1/16" (UNF 10-32)	AVQ66AE
16	PEEK	PEEK	50	0.75	1/16" (UNF 10-32)	AVS62CE
16	PEEK	PEEK	150	0.75	1/16" (UNF 10-32)	AVS63CE NEW

** Break-free rotor seal

¹ stainless steel coated with diamond-like carbon

Special purpose valves (For detailed information please check our website: www.knauer.net/valves)

Valves	Capillary connection	Max. pressure [bar]	Bore size [mm]	Order number
Column selection valve, biocompatible. Allows switching of up to 5 columns incl. bypass and reverse flow option.	1/16" (UNF 10-32)	50	0.4	AVZ52CE
Multi-injection valve, biocompatible. Allows manual and automated sample loading as well as direct injection.	1/16" (UNF 10-32)	240	0.75	AVN94CE***
Multi-injection valve, stainless steel. Allows manual and automated sample loading as well as direct injection.	1/16" (UNF 10-32)	500	0.75	AVN96AE****

*** Stator material: PEEK

**** Stator material: SST DLC

Pump heads and pump head accessories



AHB40



AHB32



AHB43



AHC20

Replacement pump heads for AZURA® Pump P 2.1S/P 4.1S and BlueShadow Pump 40P

Pump head 10 ml, stainless steel	AHB40
Pump head 10 ml, stainless steel, for high temperature dosing applications	AHB40CA
Pump head 10 ml, stainless steel, for high-temperature dosing applications, with backpiston flushing	AHB40CB
Pump head, 10 ml, stainless steel, for aqueous solutions	AHB40FA
Pump head 10 ml, ceramic	AHB32
Pump head 10 ml, ceramic with Titanium bushings	AHB32DA
Pump head 10 ml, ceramic, Titanium bushings, for aqueous solutions	AHB32GA
Pump head 10 ml, Hastelloy-C, for corrosive chemicals	AHB43
Pump head 50 ml, stainless steel	AHC20
Pump head 50 ml, stainless steel, for high temperature dosing applications	AHC20CA
Pump head 50 ml, stainless steel, for high temperature dosing applications, with backpiston flushing	AHC20CB
Pump head 50 ml, stainless steel, for aqueous solutions	AHC20FA
Pump head 50 ml, ceramic	AHC22
Pump head 50 ml, ceramic, for aqueous solutions	AHC22FA
Pump head 50 ml, Hastelloy-C, for corrosive chemicals	AHC23



A4029-1



A4021-1



A4021V2



A4038-1

Replacement pump heads for BlueShadow Pump 80P

Pump head 100 ml/min, stainless steel, 400 bar	A4029-1
Pump head 100 ml, titanium, 400 bar	A4029V2
Pump head 250 ml, stainless steel, 200 bar	A4021-1
Pump head 250 ml, titanium, 200 bar	A4021V2
Pump head 500 ml, stainless steel, 100 bar	A4038-1
Pump head 500 ml, titanium, 100 bar	A4038V2
Pump head 1000 ml, stainless steel, 50 bar	A4022-1
Pump head 1000 ml, titanium, 50 bar	A4022V2

Pump head compatibility



Max. flowrate 10 & 50 ml/min

Details	Stainless steel				Ceramic			Hastelloy-C
		For water	High-temp.	High-temp. piston seal wash		Ti-bushings	For water, Ti-bushings	
Art. no. 10 ml/min	AHB40	AHB40FA	AHB40CA	AHB40CB	AHB32	AHB32DA	AHB32GA	AHB43
Art. no. 50ml/min	AHC20	AHC20FA	AHC20CA	AHC20CB	AHC22	AHC22FA	AHC23	AHB43
AZURA® P 2.1S	X	X			X	X	X	X
AZURA® P 4.1S	X	X			X	X	X	X
BlueShadow 40P	X		X	X	X			

Max. flowrate 100 - 1 000 ml/min

	Stainless steel	Titanium (biocompatible)
Art. no. 100 ml/min	A4029-1	A4029V2
Art. no. 250 ml/min	A4021-1	A4021V2
Art. no. 500 ml/min	A4038-1	A4038V2
Art. no. 1 000 ml/min	A4022-1	A4022V2
Blueshadow 80P	X	X



Request for more options:
sales@knauer.net

Wetted materials

Art. No.	Wetted materials
AHB40, AHC20 AHB40CA, AHB40CB AHC20CA, AHC20CB	Stainless steel 316L, PEEK, Sapphire, Zirconium oxide, Ruby, Graphite fiber reinforced PTFE, FKM*
AHB40FA	Stainless steel 316L, PEEK, Sapphire, Ruby, Graphite fiber reinforced PTFE, FKM*
AHB32, AHB32DA AHC22	PEEK, Sapphire, ZrO ₂ , Al ₂ O ₃ , Ruby, Graphite fiber reinforced PTFE, FKM*
AHB43, AHC23	Hastelloy C-276, PCTFE, Sapphire, Ruby, ZrO ₂ , FFKM*
AHB32GA, AHC20FA	Titanium (AHB32GA only), PEEK, Sapphire, Al ₂ O ₃ , Ruby, Graphite fiber reinforced PTFE, FKM*
A4029-1, A4021-1, A4038-1, A4022-1	GFP (graphite fiber reinforced PTFE), ruby, sapphire, PEEK, stainless steel, zirconium oxide
A4029V2, A4021V2, A4038V2, A4022V2	GFP (graphite fiber reinforced PTFE), ruby, sapphire, titanium, PEEK, zirconium oxide

*only wetted if main gasket leaks



A06840



A06841



A068411

Check valves for pump heads

Check valve unit for 10 and 50 ml pump heads, for dosing applications	A06840
Check valve unit for 10 ml pump heads, for HPLC applications	A06841
Check valve unit for 50 ml pump heads, for HPLC applications	A06842
Spring-loaded check valve unit for 10 ml and 50 ml pump heads, for normal phase applications	A068411
Check valve unit (KEL-F) for 10 ml pump head, for aggressive substances	A068412
Check valve unit (KEL-F) for 50 ml pump head, for aggressive substances	A068422
Check valve unit stainless steel/PEEK for 100 ml and 250 ml pump heads	A1122
Check valve unit titanium/PEEK for 100 ml and 250 ml pump heads	A1122-1
Check valve unit titanium/KEL-F for 100 ml and 250 ml pump heads	A1122-2
Check valve unit stainless steel/KEL-F for 100 ml and 250 ml pump heads	A1122-3
Check valve unit stainless steel/PEEK for 500 ml and 1000 ml pump heads	A1080
Check valve unit titanium/PEEK for 500 ml and 1000 ml pump heads	A1080V1
Check valve unit titanium/KEL-F for 500 ml and 1000 ml pump heads	A1080V2
Check valve unit stainless steel/KEL-F for 500 ml and 1000 ml pump heads	A1080V3

Check valve specifications

Art. No.	A06840	A06841, A06842	A068411	A068412, A068422	A1122, A1122-1, A1122-2, A1122-3	A1080	A1080V1, A1080V2, A1080V3
Description	Dosing pump check valve	High-pressure check valve	Spring-loaded check valve	Check valve for aggressive solvents	Check valve unit for Blue Shadow Pump 80P	Check valve unit for Blue Shadow Pump 80P	Check valve unit for Blue Shadow Pump 80P
Pump head	10 ml 50 ml	10 ml 50 ml	50 ml	10 ml 50 ml	100 ml 250 ml	500 ml 1000 ml	500 ml 1000 ml
Inner diameter	1.4 mm	0.7 mm 1.2 mm	1.4 mm	0.7 mm 1.2 mm	2.0 mm	3.0 mm	3.0 mm
Wetted materials	PEEK, Ruby, Sapphire, Al ₂ O ₃	PEEK, Ruby, Sapphire, Al ₂ O ₃	PEEK, Ruby, Sapphire, Al ₂ O ₃	PCTFE, Ruby, Sapphire, Al ₂ O ₃	Stainless steel, Titanium, PEEK, PCTFE, Ruby, Sapphire	Stainless steel, PEEK, Al ₂ O ₃	Stainless steel, Titanium, PEEK, PCTFE, Al ₂ O ₃
Application	Dosing of technical grade solvents, operation at low flow rate and/or low backpressure	Accurate dosing at high pressure	Dosing of organic solvents with low conductivity (Alkanes, Furanes)	Dosing of aggressive substances	Suitable for all applications	Suitable for all applications	Suitable for all applications

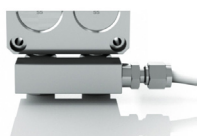

A9861



A9868



A98611



A58269

Pump head inlet fittings

Use inlet fittings to adapt the pump head to a wide range of tubes and capillaries.

The pump head inlets A9861/A9868 require an additional male connector for operation. The available options are 1/8", 4 mm or 1/4" outer diameter.

Pump head inlet for AZURA® Pump P 2.1L, BlueShadow 80P, 1/4" (NPT), stainless steel, max. flow 250 ml/min	A9861
Pump head inlet for AZURA® Pump P 2.1L, Set, 1/2"-20 UNF, PEEK with CTFE (Kel-F) adapter, including tubing 1/4" PTFE	A9868
Male connector to connect a 1/4" OD capillary to a 1/4" male NPT adapter (material: stainless steel) for A9861	A58267
Male connector to connect a 4 mm OD capillary to a 1/4" male NPT adapter (material: stainless steel) for A9861	A58268
Male connector to connect a 1/8" OD capillary to a 1/4" male NPT adapter (material: stainless steel) for A9861	A58269
Inlet bushing for prep pump heads, adapter to 3/8" tube stub	A98611
Inlet bushing for binary LPG prep pump heads, LPG inlet to 3/8" tube stub	A98612
Inlet bushing for LPG prep pump heads, LPG ternary inlet to 3/8" tube stub	A98613
Inlet-bushing kit for P 2.1S, P 4.1S, P 6.1L, 40P and S1050 pumps for pump heads 10 ml (1/8" capillaries)	A58202
Inlet bushing kit for P 2.1S, P 4.1S, P 6.1L, 40P and S1050 pumps for pump heads 10 ml (1/16" capillaries)	A58203
Inlet bushing kit for P 2.1S, P 4.1S, P 6.1L, 40P and S1050 pumps for pump heads 50 ml (1/8" capillaries)	A58204
Inlet bushing kit for P 2.1S, P 4.1S, P 6.1L, 40P and S1050 pumps for pump heads 50 ml (1/16" capillaries)	A58205



A5822



A7200

Pump head outlet fittings

Outlet-bushing kit 1/8" tube stub for S1800, 80P and P 2.1L pumps	A5822
Adapter to connect a capillary with 1/16" OD (thread: 10-32 UNF) to AZURA® Pump P2.1L or BlueShadow Pump 80P outlet (1/8", M8x1 thread), material: stainless steel, 2 pcs.	A7200

Pump accessories



A3373



A3374



A3375



A3364

Solvent filters

Mobile Phase Filter, stainless steel, 2 µm, 1/8" pipe OD, suitable for all analytical HPLC systems	A3373
Mobile Phase Filter, stainless steel, 20 µm, for 1/8" OD, compatible with the AZURA® Tubing Kit (A9650), suitable for all analytical and semi preparative HPLC systems, max. flow rate 100 ml/min	A3374
Mobile Phase Filter, stainless steel, 10 µm, for 1/8" OD, compatible with the AZURA® Tubing Kit (A9650), suitable for all analytical HPLC systems, max. flow rate 10 ml/min	A3375
Mobile Phase Filter, Biocompatible PE, 20 µm, 1/8" pipe OD, suitable for all FPLC systems, max. flow rate 500 ml/min	A3364
Inlet-bushing kit with 1/4"-PTFE Tubing and 20 µm stainless steel solvent filter (up to 250 ml/min)	A58207



PTFE tubings

Inlet tubings

PTFE tubing, 1/4" OD, 4,75 mm ID, 300 cm length	A08732
PTFE tubing, 3/8" OD, 8 mm ID, variable length	A01521
1/8" OD FEP tubing, 2.1 mm ID, 300 cm length	A9869
PFA tubing, 1/4" OD, 3,96 mm ID, variable length	A31891
PFA tubing, 1/4" OD, 4,76 mm ID, variable length	A31891-1
PFA tubing 1/8" OD, 1,6 mm ID, variable length	A31892
PFA tubing, 1/8", OD, 2,4 mm ID, variable length	A31892-1



AZZ00MB



A5830



A9853-8



AZZ10ME

Static mixers

AZURA® HPLC mixer up to 1000 bar, 50 µl mixing volume, stainless steel	AZZ00MB
AZURA® HPLC mixer up to 1000 bar, 100 µl mixing volume, stainless steel	AZZ00MC
AZURA® HPLC mixer up to 1000 bar, 200 µl mixing volume, stainless steel	AZZ00MD
AZURA® HPLC mixer up to 40 MPa, 250 µl mixing volume, PEEK (biocompatible)	AZZ10ME
HyperShear Static Mixer, (1.5 ml), high flow series, 414 bar max. pressure, stainless steel and PEEK;	A5830
Mounting bracket AZURA® L for Hypershear mixing chambers	A9853-8



A02751



A2515

Dynamic mixers

Dynamic mixing chamber (115 V), stainless steel, analytical, 1/16", up to 420 bar, 1740 µl mixing volume	A02851
Dynamic mixing chamber (250 V), stainless steel, analytical, 1/16", up to 420 bar, 1740 µl mixing volume	A0285
Dynamic mixing chamber (250 V), titanium, analytical, 1/16", up to 420 bar, 1740 µl mixing volume	A0275
Dynamic mixing chamber (115 V), titanium, analytical, 1/16", up to 420 bar, 1740 µl mixing volume	A02751
Dynamic mixing chamber (250 V), stainless steel, preparative, 1/8", up to 250 bar, 5.9 ml mixing volume	A0581
Dynamic mixing chamber (115 V), stainless steel, preparative, 1/8", up to 250 bar, 5.9 ml mixing volume	A05811
Dynamic mixing chamber (250 V), titanium, preparative, 1/8", up to 250 bar, 5.9 ml mixing volume	A70581
Dynamic mixing chamber (115 V), titanium, preparative, 1/8", up to 250 bar, 5.9 ml mixing volume	A705811
Mixing chamber extension unit for A70581/ A705811, 1 intermediate section, titanium, 4.8 ml, 3 screws 6 x 60 mm	A2515



AZZ00NA



AZZ00NB



AZZ10NB

Pulse damper

KNAUER Pulse Damper, 275 µl, stainless steel, 1/16", 1000 bar	AZZ00NA
KNAUER Pulse Damper, 290 µl, stainless steel, 1/16", 1000 bar	AZZ00NB
KNAUER Pulse Damper, 290 µl, PEEK, 1/16", 225 bar	AZZ10NB



A2035-1



A57031

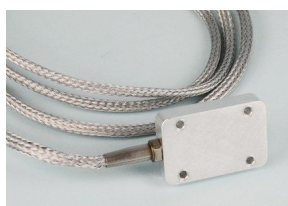

A57035-1



A70054V3

Temperature control

Pump head cooling and heating device for 10 and 50 ml/min pump heads	A2035-1
Pump head cooling and heating device for 100/250/500/1000 ml/min pump heads	A2034-1
Temperature controller for column heating sleeve	A57024
Heating element for 10 and 50 ml/min pump heads	A57035-1
Heating sleeve for HPLC column 250 x 50 mm HM D=60..100*L=311 mm 100 °C, 230V, 800W, Pt100	A57031
Eluent heating device (1 channel), 1/16", temperature range: ambient to 100°C, 5,7" display, cleanroom compatible	A70054V3
Eluent heating device (2 channels), 1/16", temperature range: ambient to 100°C, 5,7" display, cleanroom compatible	A70054V4



A96423



A96425

Maintenance kits

Maintenance kit for AZURA® Pump P 2.1S/ P 4.1S, AZURA® Pump P 6.1L, BlueShadow 40P, 10 ml pump head, including 1 set of gaskets, 2 piston rods, 2 sapphire backing rings, 2 O-rings	A96423
Maintenance kit for AZURA® Pump P 2.1S/ P 4.1S, AZURA® Pump P 6.1L, BlueShadow 40P, 50 ml pump head, including 1 set of gaskets, 2 piston rods, 2 sapphire backing rings, 2 O-rings	A96424
Maintenance kit 100 ml for AZURA® Pump P 2.1L and BlueShadow 80P, including 2 sets of gaskets, 2 piston rods, 2 springs	A96425
Maintenance kit 250 ml for AZURA® Pump P 2.1L and BlueShadow 80P, including 2 sets of gaskets, 2 piston rods, 2 springs	A96426
Maintenance kit 500 ml for AZURA® Pump P 2.1L and BlueShadow 80P, including 2 sets of gaskets, 2 piston rods, 2 springs	A96427
Maintenance kit 1000 ml for AZURA® Pump P 2.1L and BlueShadow 80P, including 2 sets of gaskets, 2 piston rods, 2 springs	A96428
Rebuild-Kit for one pump head AZURA® Pump P 2.1L and BlueShadow 80P (100ml/250 ml), Venting screw KEL-F, Check valve unit KEL-F, O-ring	A58211
Rebuild-Kit Kel-F for AZURA® Pump P 4.1S/P 2.1S/P6.1L/40P, 10 ml/min pump head	A5821-1
Rebuild-Kit Kel-F for AZURA® Pump P 4.1S/P 2.1S/P6.1L/40P, 50 ml/min pump head	A5821-2
Filter Cartridge for pump P 6.1L/40P, Titanium frit, 2 µm pore size. 50 ml/min maximum flow, High capacity filter, 60 µl volume, 3 pcs.	A9661
Filter Cartridge for pump P 6.1L/40P, Stainless steel frit, 2 µm pore size. 10 ml/min maximum flow, Volume optimized filter, 20 µl volume, 3 pcs.	A96601



A9670



A9673

Maintenance tool kits

Maintenance tool kit for 10 ml pump heads	A9670
Maintenance tool kit for 50 ml pump heads	A9671
Maintenance tool kit for 100 ml pump heads	A9672
Maintenance tool kit for 250 ml pump heads	A9673
Maintenance tool kit for 500 ml pump heads	A9674
Maintenance tool kit 1000 ml pump heads	A9675

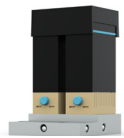

AZZ00AA-1



AZZ00AB-1

LPG modules for BlueShadow Pump 80P

LPG module for Pump 80P binary up to 800 ml/min (stainless steel)	AZZ00AA-1
LPG module for Pump 80P ternary up to 220 ml/min (stainless steel)	AZZ00AB-1



A0000TD

Material documentation for KNAUER Pumps

For operation in a regulated environment, KNAUER offers material documentation of the wetted parts for all dosing pumps according to Certificate of Compliance EN 10204-2.1 on a 2.1 material certificate level.

Material documentation for KNAUER pumps	A0000TD
---	---------

Detector accessories

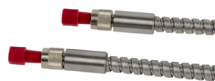

A0740

Fiber optic connectors

Fiber optic cables (2 pc), 750 mm, 2x SMA 905 600/660, polymicro	A0740
Fiber optic cables (2 pc), 750 mm, 2x SMA 905 600/660, polymicro, up to 85 °C	A0740HT
Fiber optic cables (2 pc), custom made sizes, 2x SMA 905 600/660, polymicro	A0743



A4123



A4125



A4126



A4128

Test cells

Test cell	A4123
Test cell with fiber optic connectors for AZURA® UVD 2.1S, UVD 2.1L and Smartline 2520, 2500 and 2600, BlueShadow 40D, BlueShadow 50D	A4125
Test cell holmium oxid filter	A4126
Test cell with holmium filter and fiber optic connectors for AZURA® UVD 2.1S, UVD 2.1L and Smartline 200, 2520, 2500, 2550 and 2600 detectors, BlueShadow 40D, BlueShadow 50D	A4128
Test cell, WG 280 filter stray light	A4146
Test cell with stray light filter and fiber optic connectors for AZURA® UVD 2.1S, UVD 2.1L and Smartline 2520, 2500 and 2600, BlueShadow 40D, BlueShadow 50D	A4148



A4061XB



A4074

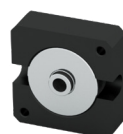

A4042



A4044HT

Analytical flow cells

10 mm path length, 10 µl, 1/16", 300 bar, stainless steel, with heat exchanger one sided inlet and outlet, classical KNAUER flow cell	A4061XB
10 mm path length, 10 µl, 1/16", 300 bar, stainless steel, fiber optic connectors, classical KNAUER flow cell	A4074
3 mm path length, 2 µl, 1/16", stainless steel, classical KNAUER flow cell	A4042
3 mm path length, 2 µl, 1/16", 300 bar, 85 °C, stainless steel, fiber optic connectors, classical KNAUER flow cell	A4044HT
3 mm path length, 2 µl, 1/16", 30 bar, biocompatible, classical KNAUER flow cell	A4045
3 mm path length, 2 µl 1/16", 30 bar, biocompatible, fiber optic connectors, classical KNAUER flow cell	A4047

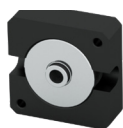

A4066



A4078

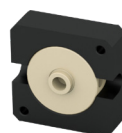

A4067



A4079

Preparative flow cells

2 mm path length, 1/8", 200 bar, stainless steel, changeable to 0.5/1.25 mm, classical KNAUER flow cell	A4066
2 mm path length, 1/8", 200 bar, stainless steel, fiber optic connectors, changeable to 0.5/1.25 mm, classical KNAUER flow cell	A4078
2 mm path length, 1/8", 100 bar, biocompatible, changeable to 0.5/1.25 mm, classical KNAUER flow cell	A4067
2 mm path length, 1/8", 100 bar, biocompatible, fiber optic connectors, changeable to 0.5/1.25 mm, classical KNAUER flow cell	A4079
2 mm path length, 1/4" angular connections, 200 bar, stainless steel, changeable to 0.5/1.25 mm, without fittings, classical KNAUER flow cell	A4068
2 mm path length, 1/4" straight connections, 200 bar, stainless steel, changeable to 0.5/1.25 mm, without fittings, classical KNAUER flow cell	A4068-2
2 mm path length, 1/4" angular connections, 200 bar, stainless steel, fiber optic connectors, changeable to 0.5/1.25 mm	A4081
variable path length and variable volume, 1/4" straight connections, 200 bar, stainless steel, fiber optic connectors	A4081V2
0.5 mm path length, 3 µl, 1/16", 200 bar, stainless steel, classical KNAUER flow cell	A4069
0.5 mm path length, 3 µl, 1/16", 200 bar, stainless steel, fiber optic connectors, classical KNAUER flow cell	A4089
0.5 mm path length, 3 µl, 1/16", 100 bar, biocompatible, classical KNAUER flow cell	A4095
0.5 mm path length, 3 µl, 1/16", 100 bar, biocompatible, fiber optic connectors, classical KNAUER flow cell	A4096



A4152-1



A4154

Preparative flow cells - fiber optics

10 mm path length, 3/8" TRI-Clamp connections, 10 bar, biocompatible, fiber optic connectors	A4154-1
7 mm path length, 3/8" TRI-Clamp connections, 10 bar, biocompatible, fiber optic connectors	A4152-1
2 mm path length, 1/2" TRI-Clamp connections, 80 bar, stainless steel, fiber optic connectors, changeable to 0.5/1.25 mm	A4154
2 mm path length, 3/4" TRI-Clamp connections, 80 bar, stainless steel, fiber optic connectors, changeable to 0.5/1.25 mm	A4155
2 mm path length, 3/8" TRI-Clamp connections, 80 bar, stainless steel, fiber optic connectors, changeable to 0.5/1.25 mm	A4152
2 mm path length, 1/4" TRI-Clamp connections, 80 bar, stainless steel, fiber optic connectors, changeable to 0.5/1.25 mm	A4153

Consumables



A7205



A7206



A7207



A7210

Bushings for 1/8" UNF 1/4-28 coned*

1/8" Bushing, short, for UNF 1/4-28 thread, Stainless steel	A7205
1/8" Bushing, long, for UNF 1/4-28 thread, Stainless steel	A7206
1/8" Bushing, long, UNF 1/4-28 thread, Stainless steel, for biconical sealing	A7207
1/8" Blind fitting, for UNF 1/4-28 thread, Stainless steel	A7208
1/8" Bushing with integrated sealing ring, for UNF 1/4-28 thread, PEEK	A7209
1/8" Bushing for biconical sealing, UNF 1/4-28 thread, PEEK	A7210
1/8" Bushing with integrated seal ring, for UNF 1/4-28 thread, PCTFE	A7211
1/8" Blind plug, for UNF 1/4-28 thread, PEEK	A7212



A7218



A7219



A7220



A7204

Adapters and couplings for 1/8" UNF 1/4-28 coned*

Coupling to connect two 1/8" capillaries, 1/8" (UNF 1/4-28) to 1/8" (UNF 1/4-28), Stainless steel	A7218
Coupling to connect two 1/8" capillaries, 1/8" (UNF 1/4-28) to 1/8" (UNF 1/4-28), Titanium	A7219
Coupling to connect two 1/8" capillaries, 1/8" (UNF 1/4-28) to 1/8" (UNF 1/4-28), PEEK	A7220
Coupling to connect 1/16" with 1/8" capillary 1/8" (UNF 1/4-28) to 1/16" (UNF 10-32), Stainless steel	A7221
Coupling to connect 1/16" with 1/8" capillary, 1/8" (UNF 1/4-28) to 1/16" (UNF 10-32), Titanium	A7222
Coupling to connect 1/16" with 1/8" capillary, 1/8" (UNF 1/4-28) to 1/16" (UNF 10-32), PEEK	A7223
Adapter to connect a capillary with 1/16" OD (thread: 10-32 UNF) to 1/8" (thread: 1/4-28 UNF coned), Stainless steel	A7204
Adapter to connect a capillary with 1/16" OD (thread: 10-32 UNF) to 1/8" (thread: 1/4-28 UNF coned), material: PEEK	A7224

* These fittings are solely for the use with the V 4.1 valves for 1/8" capillaries with UNF 1/4-28 thread. Other devices use a M8x1 thread.



A7213



A7214



A7215



A7217

Ferrules, seal rings and clamp rings for 1/8" UNF 1/4-28 coned*

1/8" Ferrule for wrench-tight fittings, ports with UNF 1/4-28 thread, Stainless steel	A7213
Split-grooved clamp ring for 1/8" capillary, for ports with UNF 1/4-28 thread, Stainless steel	A7214
Split-grooved clamp ring for 1/8" capillary, for ports with UNF 1/4-28 thread, Titanium	A7215
Biconical seal ring for 1/8" capillary, for ports with UNF 1/4-28 thread, PETP	A7216
Seal ring for 1/8" capillary, for ports with UNF 1/4-28 thread, PEEK	A7217
1/8" Ferrule for wrench-tight fittings, ports with UNF 1/4-28 thread, Titanium	A7225

* These fittings are solely for the use with the V 4.1 valves for 1/8" capillaries with UNF 1/4-28 thread. Other devices use a M8x1 thread.



A9646



A9646-1



A9645



A9647

K-Connect system fittings

K-Connect Fingertight Fitting, PEEK, long, Set of 2, incl. ferrule, UNF 10/32 Thread for 1/16 " K-Connect and PEEK Capillaries	A9646
K-Connect Fingertight Fitting, PEEK, long, Set of 10, incl. ferrule, UNF 10/32 Thread for 1/16 " K-Connect and PEEK Capillaries	A9646-1
K-Connect Fingertight Fitting, stainless steel, long, Set of 2, incl. ferrules, UNF 10/32 Thread for 1/16 " K-Connect Capillaries	A9645
K-Connect Fingertight Fitting, stainless steel, long, Set of 10, incl. ferrules, UNF 10/32 Thread for 1/16 " K-Connect Capillaries	A9645-1
K-Connect Standard Fitting, stainless steel, Set of 2, incl. ferrule, UNF 10/32 Thread for 1/16 " K-Connect Capillaries	A9647
K-Connect Standard Fitting, stainless steel, Set of 10, incl. ferrule, UNF 10/32 Thread for 1/16 " K-Connect Capillaries	A9647-1



A0484



A1239



A0482

Split-grooved clamping rings

4 Split-grooved clamping rings for capillaries with 1/16" OD	A0484
4 Split-grooved clamping rings for capillaries with 1/8" OD	A1239
100 Split-grooved clamping rings for capillaries with 1/16" OD	A0482



A0139



A0140



A1062



A0232

Sealing rings

30 Sealing rings for capillaries with 1/16" OD, PETP	A0139
100 Sealing rings for capillaries with 1/16" OD, PETP	A0140
10 Sealing rings for capillaries with 1/16" OD, PEEK	A1062
10 Sealing rings for capillaries with 1/8" OD, PETP	A0232
10 Sealing rings for capillaries with 1/8" OD, PEEK	A1063



A1070



A1022



A0738

Biconical sealing rings

10 Biconical sealing rings with 1/16", PEEK	A1070
10 Biconical sealing rings with 1/16", PETP	A1022
10 biconical sealing rings 1/8" PETP	A0738



A0112



A0113



A0115



A0116

Bushings for 1/16" capillaries, stainless steel

10 Bushings for capillaries with 1/16" OD, stainless steel, wrench caliber 1/4", UNF 10-32, short	A0112
25 Bushings for capillaries with 1/16" OD, stainless steel, wrench caliber 1/4", UNF 10-32, short	A0113
3 Bushings for capillaries with 1/16" OD, stainless steel, wrench caliber 1/4", UNF 10-32, long	A0115
10 Bushings for capillaries with 1/16" OD, stainless steel, wrench caliber 1/4", UNF 10-32, long	A0116



A0830

Bushings for 1/8" capillaries, stainless steel

10 Bushings for capillaries with 1/8" OD, M8x1, wrench caliber 10, stainless steel	A0830
--	-------



A0110



A0111



A0874



A01101

Ferrules for capillaries

30 Ferrules for capillaries with 1/16" OD, stainless steel	A0110
100 Ferrules for capillaries with 1/16" OD, stainless steel	A0111
10 Ferrules for capillaries with 1/8" OD, stainless steel	A0874
10 Ferrules, Hastelloy, for capillaries with 1/16" OD	A01101
10 Ferrules, Titanium, for capillaries with 1/16" OD	A01102



A0141



A0142



A0144



A0145

Bushings for capillaries PEEK & PETP

Bushings for 1/16" capillaries, PETP, knurled, UNF 10-32, short, 10 pcs.	A0141
Bushings for 1/16" capillaries, PETP, knurled, UNF 10-32, short, 30 pcs.	A0142
Bushings for 1/16" capillaries, PETP, UNF 10-32, long, 10 pcs.	A0144
Bushings for 1/16" capillaries, PETP, with integrated sealing cone, knurled, UNF 10-32, short, 10 pcs.	A0145
Bushings for 1/16" capillaries, with integrated sealing cone, knurled, PEEK, UNF 10-32, 10 pcs.	A0584
Bushings for 1/8" capillaries, PETP, with integrated sealing cone, M8x1, knurled, short, 10 pcs.	A0733
Bushing for 1/16" capillaries, PEEK, short Hex, with integrated sealing cone, 5 pcs.	A25011
Bushing for 1/16" capillaries, PEEK, long Hex, with integrated sealing cone, 5 pcs	A25021



A5829



A58291

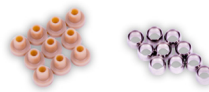

A58292



A58293

Flat bottom fittings and adapters

Bushings flat bottom for 1/8" capillaries, PEEK, Super flangeless, 1/4-28, 10 pcs.	A5829
Bushings flat bottom for 1/16" capillaries, PEEK, Super flangeless, 1/4-28, 10 pcs.	A58291
Ferrules for 1/16" capillaries and flat bottom bushings, PEEK, with lock ring (stainless steel), for Super flangeless bushings, 10 pcs.	A58292
Ferrules for 1/8" capillaries and flat bottom bushings, PEEK, with lock ring (stainless steel), for Super flangeless bushings, 10 pcs.	A58293
Ferrules for 1/8" capillaries and flat bottom bushings, ETFE, with lock ring (stainless steel), for Super flangeless bushings, 10 pcs.	A58294
Adapter PEEK 1/8" flat bottom internal on 1/16" external 10/32 thread	A1982
Adapter PEEK 1/8" external thread on 1/16" flat bottom internal thread	A05841



A0146



A0147



A0582



A0734

Blind plugs

Blind plugs, 1/16", PETP, knurled, UNF 10-32, short, 10 pcs.	A0146
Blind plugs, 1/16", PETP, knurled, UNF 10-32, short, 30 pcs.	A0147
Blind plugs, 1/16", PEEK, knurled, UNF 10-32, short, 10 pcs.	A0582
Blind plugs, 1/8", PETP, knurled, M8x1, short, 10 pcs.	A0734



A0148



A0149



A0233



A0233-1

Couplings, PETP/PEEK

Coupling to connect 2 capillaries with 1/16" OD (material: PEEK/PETP, thread: UNF10-32), including 2 bushings and sealing rings, 0.5 mm bore, suitable for classical HPLC, 1 pc.	A0148
Coupling to connect 2 capillaries with 1/16" OD (material: PEEK/PETP, thread: UNF10-32), including 2 bushings and sealing rings, 0.5 mm bore, suitable for classical HPLC, 5 pcs.	A0149
Coupling to connect 2 capillaries with 1/16" OD (material: PEEK, thread: 10-32 UNF), including 2 one-piece PEEK fittings, 0.5 mm bore, suitable for classical HPLC	A0233
Coupling to connect 2 capillaries with 1/16" OD (material: PEEK, thread: 10-32 UNF), without fittings, 0.5 mm bore, suitable for classical HPLC	A0233-1
Coupling to connect 2 capillaries with 1/16" and 1/8"OD (material: PEEK, thread: 10-32 UNF, M8x1), including 2 one piece fittings (1x 1/16", 1x 1/8"), 1 mm bore	A1407
Coupling to connect 2 capillaries with 1/8"OD (material: PEEK, thread: M8x1), including 2 one piece fittings 1/8", 2 mm bore, suitable for preparative HPLC	A14071



A0117V1



A2512



A7218

Couplings, stainless steel/titanium

Coupling to connect 2 capillaries with 1/16" OD (material: titanium, thread: 10-32 UNF), including 2 bushings and ferrules, 0.5 mm bore, suitable for classical HPLC A0117V1

Coupling to connect 2 capillaries with 1/16" OD (material: stainless steel, thread: 10-32 UNF), including 2 bushings and ferrules, 0.5 mm bore, suitable for classical HPLC A0117

Coupling to connect 2 capillaries with 1/16" OD (material: stainless steel, thread: 10-32 UNF), including 2 bushings and ferrules, 0.5 mm bore, suitable for classical HPLC, 5 sets A0118

Coupling to connect 2 capillaries with 1/16" OD (material: stainless steel, thread: 10-32 UNF), including 2 bushings and ferrules, 0.5 mm bore, suitable for classical HPLC, 25 sets A0119

Coupling to connect 2 capillaries with 1/8" OD (material: stainless steel, thread: M8x1), including 2 bushings and ferrules, 2 mm bore, suitable for preparative HPLC A2512

Coupling to connect a capillary with 1/16" OD to a capillary with 1/8" OD (material: stainless steel, thread: M8x1, 10-32 UNF), 1 mm bore A2513

Coupling to connect two 1/8" capillaries, 1/8" (UNF 1/4-28) to 1/8" (UNF 1/4-28), stainless steel A7218

Coupling to connect two 1/8" capillaries, 1/8" (UNF 1/4-28) to 1/8" (UNF 1/4-28), Titanium A7219

Coupling to connect two 1/8" capillaries, 1/8" (UNF 1/4-28) to 1/8" (UNF 1/4-28), PEEK A7220



A2511



A0120



A58260



A58261

T-connectors, stainless steel/titanium

T-connector to connect 3 capillaries with 1/8" OD (material: stainless steel, thread: M8x1), including 3 bushings and ferrules A2511

T-connector to connect 3 capillaries with 1/16" OD (material: stainless steel, thread: 10-32 UNF), including 3 bushings and ferrules A0120

T-connector to connect 3 capillaries with 1/8" OD (material: stainless steel, Swagelok®) A58260

T-connector to connect 3 capillaries with 1/4" OD (material: stainless steel, Swagelok®) A58261

T-connector to connect 3 capillaries with 1/4" OD (material: titanium, Swagelok®) A58262



A2511-1

T-connectors, PEEK

T-connector to connect 3 capillaries with 1/16" OD (material: PEEK, thread: 10-32 UNF), without bushings A150-1

T-connector to connect 3 capillaries with 1/8" OD (material: PEEK, thread: M8x1), including 2 one piece PEEK fittings 1/8" A2511-1



A0121



A1096

X-connectors, stainless steel

X-connector to connect 4 capillaries with 1/16" OD (material: stainless steel, thread: 10-32 UNF), including 4 bushings and ferrules	A0121
X-connector to connect 4 capillaries with 1/8" OD (material: stainless steel, thread: M8x1), including 4 bushings and ferrules	A1096
X-connector to connect 4 tubings with 1/4" OD (material: stainless steel, Swagelok®) for 1000 ml/ min Systems	A58272



A0151

X-connectors, PEEK

X-connector to connect 4 capillaries with 1/16" OD (material: PEEK, thread: 10-32 UNF), including 4 one-piece fittings	A0151
--	-------



A5800



A5805

Pressure release valves

Pressure Release Valve Kit for AZURA® pump P 2.1L and Pump 1800 (3.4 to 24 bar), 1/8", stainless steel, cross piece titanium	A5801
Pressure Release Valve for AZURA® pump P 2.1L and Pump 1800 (without spring), 1/4", stainless steel	A5802
Back-Pressure Regulator/pressure relief valve kit for 1/16" OD tubing, stainless steel, provides a constant back-pressure of 3 bar, contains pressure relief valve tee and fittings for 1/16"	A5805



A70087



A70088



A70084



A5804

Backpressure regulators

Back-Pressure Regulator for 1/16" OD tubing, 10-32 threads, PEEK, Range 1-20 bar (15-300 psi)	A70087
Back-Pressure Regulator for 1/16" OD tubing, 10-32 threads, PEEK, Range 20-103 bar (300-1500 psi)	A70088
Back-Pressure Regulator for 1/16" OD tubing, 10-32 threads, stainless steel, Range 90-300 bar (1300-4200 psi)	A70084
Spare membranes for Back-Pressure Regulators A70084, A70087, A70088	A70082
Back-Pressure Regulator/pressure relief valve for 1/8" and 1/16" OD tubing, 134 µl volume, PEEK, provides a constant back-pressure of 1.4 bar (20 psi), contains pressure relief valve tee and fittings for 1/8" and 1/16"	A5804
Back-Pressure Regulator for 1/16" OD tubing, 134 µl volume, PEEK, provides a constant back-pressure of 0.3 bar (5 psi), contains Y assembly and fittings	A5804-1



Stainless steel capillary

Capillaries 1/16", stainless steel

Stainless steel, 1/16" OD, 0.1 mm ID, 300 cm length, 1 pcs.	A0130
Stainless steel, 1/16" OD, 0.25 mm ID, 300 cm length, 1 pcs.	A0131
Stainless steel, 1/16" OD, 0.5 mm ID, 300 cm length, 1 pcs.	A0132
Stainless steel, 1/16" OD, 0.7 mm ID, 300 cm length, 1 pcs.	A0133
Stainless steel, 1/16" OD, 1 mm ID, 300 cm length, 1 pcs.	A0134
Stainless steel, 1/16" OD, 0.1 mm ID, 10 cm length, 10 pcs.	A0123
Stainless steel, 1/16" OD, 0.1 mm ID, 20 cm length, 10 pcs.	A0124
Stainless steel, 1/16" OD, 0.1 mm ID, 30 cm length, 10 pcs.	A0125
Stainless steel, 1/16" OD, 0.25 mm ID, 10 cm length, 10 pcs.	A0126
Stainless steel, 1/16" OD, 0.25 mm ID, 20 cm length, 10 pcs.	A0127
Stainless steel, 1/16" OD, 0.25 mm ID, 30 cm length, 10 pcs.	A0128

Capillaries 1/8", stainless steel

Stainless steel, 1/8" OD, 1.6 mm ID, 150 cm length, 1 pcs.	A0639
Stainless steel, 1/8" OD, 2.2 mm ID, 150 cm length, 1 pcs.	A0640

Capillaries 1/16", titanium

Titanium, 1/16" OD, 0.7 mm ID, 50 cm length, 1 pcs.	A0506
---	-------



A58263



A58264



A58267



A58273

Swagelok® unions & reducing unions, stainless steel

Union to connect 2 capillaries with 1/4" OD, material: stainless steel, Swagelok®	A58263
Reducer to connect a capillary with 3/8" OD to a capillary with 1/4" OD, material: stainless steel, Swagelok®	A58264
Reducer to connect a capillary with 8 mm OD to a capillary with 1/4" OD, material: stainless steel, Swagelok®	A58265
Reducer to connect a capillary with 1/8" OD to a capillary with 1/4" OD, material: stainless steel, Swagelok®	A58266
Reducer to connect a capillary with 1/16" OD to a 1/8" OD pipe, material: stainless steel, Swagelok®	A58270
Reducer to connect a capillary with 1/8" OD to a 1/4" pipe union, material: stainless steel, Swagelok®	A58271
Reducer to connect a capillary with 4 mm OD to a 1/8" pipe union, material: stainless steel, Swagelok®	A58282
Male connector to connect a 1/4" OD capillary to a 1/4" male NPT adapter (material: stainless steel) for A9861	A58267
Male connector to connect a 4 mm OD capillary to a 1/4" male NPT adapter (material: stainless steel) for A9861	A58268
Male connector to connect a 1/8" OD capillary to a 1/4" male NPT adapter (material: stainless steel) for A9861	A58269
Reducer for 1/4" OD capillary to 1/8" OD pipe socket, material: stainless steel, Swagelok®	A582713
Reducer to connect a 1/16" tube socket to 1/4" pipe union, material: stainless steel, Swagelok®	A58273



A5800



A5800V1

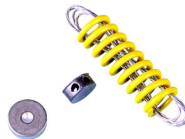

Swagelok® pressure release valves

Pressure Release Valve Kit for AZURA® pump P 2.1L and BlueShadow pump 80P (25 to 50 bar), 1/8", stainless steel, cross piece titanium	A5800
Pressure Release Valve for AZURA® pump P 2.1L and BlueShadow pump 80P (up to 50 bar), 1/8", titanium	A5800V1
Spring for pressure release valve, 25 - 50 bar	M1070
Spring for pressure release valve, 3.4-24 bar	M1080

Software

Mobile Control (Chrom) for Windows 10

With the hand-held Mobile Control and Mobile Control Chrom software you have your AZURA® devices at your fingertips. Remotely control and monitor your devices and enjoy the touch-screen-optimized user interface. Choose Mobile Control as an easy-to-use and cost-effective device control solution!

Mobile Control provides full access to AZURA® devices. Change device settings, set operating parameters, automate device control or check the system status... Mobile Control features all functionalities of a device display.

Do you want to record the pressure trace of the pumps? Mobile Control Chrom features data acquisition in addition to full device control.

Why to use Mobile Control (Chrom) software

Mobile Control is an easy user interface to control one or several devices from one tablet, laptop or PC. The software supports all functionalities of the AZURA® devices.

Save space: Mobile Control runs on a tablet. Especially in labs with little space avoiding a desktop PC with keyboard and monitor can be a decisive factor. The touch-optimized user interface allows device control using just your fingers.

Save time: Mobile Control convinces due to an intuitive user interface and a clearly structured menu function. The training period is minimal in comparison to a complex CDS.

Free updates: With every release new features are available. Download the current version for free.

Free trial: To evaluate if Mobile Control holds up to your expectations, you can download the software and test the free trial option. Perfect for those who'd like to try before they buy.

Customized software design: Mobile Control is made by KNAUER and can be adapted to the requirements of our OEM partners.



Specifications

Software

Software name	Mobile Control - basic display software for AZURA devices without data acquisition Mobile Control Chrom - basic display software for AZURA devices with data acquisition
Operating system	Windows 10
Field of application	Display software, device control,

Expandability

Stand-alone	yes
Multi-user environment	yes
Report functions	yes



Free demo version:
www.knauer.net/mobilecontrol

Ordering details:

Software

A9607	Mobile Control for AZURA® devices without data acquisition including tablet and mount
A9608	Mobile Control Chrom for AZURA® devices with data acquisition including tablet and mount
A9610	Mobile Control for AZURA® devices without data acquisition
A9612	Mobile Control Chrom for AZURA® devices with data acquisition
A9614	Upgrading Mobile Control to Mobile Control Chrom gaining data acquisition

Accessories

A96181	USB-LAN ADAPTER Network adapter USB 2.0 ↔ 10/100 Ethernet for tablets
A64809	WLAN Router, 8-port Gigabit RJ-45
A64809INT	WLAN Router with international power supply wo plug, 8-port Gigabit RJ-45
A64811	Single device WLAN router for Mobile Control - 1x RJ45, 10/100 MBit; WLAN
A9615	Tablet lock with stand for all tablets
A9616	Tablet lock for all tablets
A9617	Mobile Control Mount - flexible tablet mount for 7-10" tablets

Services

Consulting

Do you need help choosing the right pump for your application? Ask our friendly support via sales@knauer.net.

Maintenance

KNAUER maintains your devices to ensure your process is working without any failure. You can order a preventive maintenance service at your place or simply ship your devices to KNAUER.

Do you need more information? Just contact our support team via support@knauer.net.



Note: You can maintain the pump and its pump head individually!

Self service training

Our experienced trainers can show you how to maintain the pump head on your own. After the training you are able to perform routine maintenance and repair your pump head in case of malfunctions.

Get an offer at academy@knauer.net.

Flow rate calibration

Do you observe a decrease of your pump's flow rate precision? Just send your pump unit to KNAUER, we will fix that for you.

Rebuild service

Our pumps can be equipped with several components in order to adapt them to a wide range of dosing tasks. Our service team can install them for you or you can do it yourself after the completion of a KNAUER training.

Technical Support

Do you need help in any kind of way? Just call our friendly support team or write an E-mail:

Phone: +49 30 809727-111

E-mail: support@knauer.net



Conversion tables

Dimensions

mm	inches
0.10	0.004"
0.12	0.005"
0.15	0.006"
0.25	0.010"
0.40	0.016"
0.50	0.020"
0.75	0.030"
1.00	0.040"
1.50	0.060"
2.00	0.080"
4.60	0.180"
6.00	0.236"
6.40	0.253"
7.00	0.276"
10.00	0.400"

inches	mm
1/32"	0.8
1/16"	1.6
1/8"	3.2
1/4"	6.4
3/8"	9.5
1/2"	12.7
1"	25.4

Tubing volume/length

Tubing ID	µl/cm	µl/in
0.004"	0.08	0.21
0.005"	0.13	0.32
0.010"	0.51	1.29
0.015"	1.14	2.90
0.020"	2.03	5.15
0.025"	3.17	8.04
0.030"	4.56	11.58
0.040"	8.11	20.59
0.060"	18.24	46.33
0.070"	24.83	63.06
0.085"	36.61	92.99

Pressure

MPa	bar	psi
5	50	725
10	100	1 450
20	200	2 901
30	300	4 351
40	400	5 802
50	500	7 252
60	600	8 702
70	700	10 153
80	800	11 603
90	900	13 054
100	1 000	14 504
110	1 100	15 954
120	1 200	17 405
130	1 300	18 855
140	1 400	20 306
150	1 500	21 756
160	1 600	23 206
170	1 700	24 657
180	1 800	26 107
190	1 900	27 558
200	2 000	29 008

Temperature

°C	°F	°C	°F	°C	°F
-40	-40	65	149	170	338
-35	-31	70	158	175	347
-30	-22	75	167	180	356
-25	-13	80	176	185	365
-20	-4	85	185	190	374
-15	5	90	194	195	383
-10	14	95	203	200	392
-5	23	100	212	205	401
0	32	105	221	210	410
5	41	110	230	215	419
10	50	115	239	220	428
15	59	120	248	225	437
20	68	125	257	230	446
25	77	130	266	235	455
30	86	135	275	240	464
35	95	140	284	245	473
40	104	145	293	250	482
45	113	150	302	255	491
50	122	155	311	260	500
55	131	160	320	265	509
60	140	165	329	270	518

Chemical compatibility of wetted parts



Note: The user takes the responsibility for using the fluids and chemicals in an appropriate and safe way. If there is any doubt, contact the Technical Support of the manufacturer.

General

The device is very resistant against a variety of commonly used eluents. However, make sure that no eluents or water come in contact with the device or enter into the device. Some organic solvents (such as chlorinated hydrocarbons, ether) may cause coating damage or loosen glued components by improper handling. Even small quantities of other substances, such as additives, modifiers, or salts can influence the durability of the materials. Exposure time and concentration have a high impact on the resistance.

The following list contains information about the chemical compatibility of all wetted materials which are used in devices made by KNAUER. The data bases on a literature research on the manufacturer specifications of the materials.

All resistances mentioned here are for use at temperatures up to 40 °C, unless stated otherwise. Please note that higher temperatures can significantly affect the stability of different materials.

Polymers

Polyetheretherketone (PEEK)

PEEK is a durable and resistant plastic and, next to stainless steel, the standard material in HPLC. It can be used at temperatures up to 100 °C and is highly chemical resistant against almost all commonly used solvents in a pH range of 1-12.5. PEEK is potentially moderate resistant against oxidizing and reducing solvents.

Therefore, do not use the following solvents: Concentrated and oxidizing acids (such as nitric acid solution, sulfuric acid), halogenated acids (such as hydrofluoric acid, hydrobromic acid) and gaseous halogens. Hydrochloric acid is approved for most applications.

In addition, the following solvents can have a swelling effect and may have an impact on the functionality of the built-in components: Methylene chloride, THF and DMSO in any concentration such as acetonitrile in higher concentrations.

Polyethylene terephthalate (PET, outdated PETP)

PET is a thermoplastic and semi-crystalline material with high wear resistance. It is resistant against diluted acids, aliphatic and aromatic hydrocarbons, oils, fats and alcohols, but not against halo-genated hydrocarbons and ketones. Since PET belongs chemically to esters, it is not compatible with inorganic acids, hot water and alkalis. Maximum operating Temperature: up to 120 °C.

Polyimide (Vespel®)

This material is wear-resistant and permanent resilient thermally (up to 200 °C) as well as mechanically. It is chemically broadly inert (pH range 1-10) and is especially resistant against acidic to neutral and organic solvents, but vulnerable to pH strong chemical or oxidizing environments: It is incompatible with concentrated mineral acids (such as sulfuric acid), glacial acetic acid, DMSO and THF. In addition, it will be disintegrated by nucleophilic substances like ammonia (such as ammonium salts under alkaline conditions) or acetate.

Ethylene-tetrafluorethylene copolymer (ETFC, Tefzel®)

This fluorinated polymer is highly resistant against neutral and alkaline solvents. Some chlorinated chemicals in connection with this material should be handled with care. Maximum operating temperature is 80 °C.

Perfluorethylenpropylen-Copolymer (FEP), Perfluoralkoxy-Polymer (PFA)

These fluorinated polymers hold similar features as PTFE, but with a lower operation temperature (up to 205 °C). PFA is suitable for ultrapure applications, FEP can be used universally. They are resistant against almost all organic and inorganic chemicals, except elemental fluorine under pressure or at high temperatures and fluorine-halogen compounds.

Polyoxymethylene (POM, POM-H-TF)

POM is a semi-crystalline, high-molecular thermoplastic material which stands out due to its high stiffness, low friction value and thermic stability. It can even substitute metal in many cases. POM-H-TF is a combination of PTFE fibres and acetal resin and is softer and has better slip properties as POM. The material is resistant against diluted acids (pH > 4) as well as diluted lyes, aliphatic, aromatic and halogenated hydrocarbons, oils and alcohols. It is not compatible with concentrated acids, hydrofluoric acid and oxidizing agent. Maximum operating temperature is 100 °C.

Polyphenylene sulfide (PPS)

PPS is a soft polymer which is known for its high break resistance and very high chemical compatibility. It can be used with most organic, pH neutral to pH high, and aqueous solvents at room temperature without concerns. However, it is not recommended for using with chlorinated, oxidizing and reducing solvents, inorganic acids or at higher temperatures. Maximum operating temperature: 50 °C.

Polytetrafluorethylene (PTFE, Teflon®)

PTFE is very soft and anti-adhesive. This material is resistant against almost all acids, lyes and solvents, except against fluid sodium and fluoride compounds. In addition, it is temperature-resistant from -200 °C to +260 °C.

System AF™

This amorphous perfluorinated copolymer is inert against all commonly used solvents. However, it is soluble in perfluorinated solvents like Fluorinert® FC-75 and FC-40, and Fomblin perfluor-polyether solvents from Ausimont. In addition, it is affected by Freon® solvents.

Polychlorotrifluorethylene (PCTFE, Kel-F®)

The semi-crystalline thermoplastic material is plasticizer-free and dimensionally stable, even in a wide temperature range (-240 °C to +205 °C). It is moderately resistant against ether, halogenated solvents and toluene. Halogenated solvents over +60 °C and chlorine gas should not be used.

Fluorinated rubber (FKM)

The elastomer consisting of fluorinated hydrocarbon stands out due to a high resistance against mineral oils, synthetic hydraulic fluids, fuels, aromatics, and many organic solvents and chemicals. However, it is not compatible with strong alkaline solvents (pH value >13) like ammonia, and acidic solvents (pH value <1), pyrrole and THF. Operating temperature: Between -40 °C and +200 °C.

Perfluorinated rubber (FFKM)

This perfluoro elastomer has a higher fluorine content as fluorinated rubber and is therefore chemically more resistant. It can be employed at higher temperatures (up to 275 °C). It is not compatible with pyrrole.

Metals

Stainless steel

Stainless steel is, apart from PEEK, the standard material in HPLC. Steels with WNr. 1.4404 (316L) are used, or with a mixture of higher compatibility.

They are inert against almost all solvents. Exceptions are biological applications which are metal ion sensitive, and applications with extreme corrosive conditions. These steels, in comparison to commonly used steels, are increasingly resistant against hydrochloric acid, cyanides and other halogen acids, chlorides and chlorinated solvents.

The use in ion chromatography is not recommended. In case of electrochemical applications, a passivation must be executed first.

Hastelloy®-C

This nickel-chrome-molybdenum alloy is extremely resistant to corrosion, especially against oxidizing, reducing and mixed solvents, even at high temperatures. This alloy may be used in combination with chlor, formic acid, acetic acid and saline solutions.

Titanium, titanium alloy (TiA16V4)

Titanium has a low weight and a high hardness and stability. It stands out due to its very high chemical compatibility and biocompatibility. Titanium is applied when neither stainless steel nor PEEK are usable.

Non-metals

Diamond-like carbon (DLC)

This material is characterized by a high hardness, a low coefficient of friction and thus low wear. In addition, it is highly biocompatible. DLC is inert against all acids, alkalis and solvents commonly used in HPLC.

Ceramic

Ceramic is resistant against corrosion and wear and is fully biocompatible. An incompatibility against acids, alkalis and solvents commonly used in HPLC is not known.

Alumina (Al₂O₃)

Due to their high resistance to wear and corrosion, alumina ceramic is used as a coating for mechanically stressed surfaces. It is a biocompatible material with low thermal conductivity and low thermal expansion.

Zirconium oxide (ZrO₂)

Zirconia ceramics are characterized by their high mechanical resistance, which makes them particularly resistant to wear and corrosion. It is also biocompatible, has low thermal conductivity and is resistant to high pressures.

Sapphire

Synthetic sapphire is virtually pure monocrystalline alumina. It is biocompatible and very resistant to corrosion and wear. The material is characterized by a high hardness and a high thermal conductivity.

Ruby

Synthetic ruby is monocrystalline alumina and gets its red color by the addition of some chromium oxide. It is biocompatible and very resistant to corrosion and wear. The material is characterized by a high hardness and a high thermal conductivity.

Mineral wool

This insulating material consists of glass or stone wool fibres and isolates in high oxidizing conditions and at high temperatures. Mineral wool is valid as commonly inert against organic solvents and acids.

Glass, glass fibre, quartz, quartz glass

These mineral materials are resistant against corrosion and wear and are mostly chemical inert. They are compatible with oils, fats and solvents and show a high resistance against acids and lyes up to pH values of 3-9. Concentrated acids (especially hydrofluoric acid) may embrittle and corrode the minerals. Lyes may ablate the surfaces slowly.

Terms and conditions

1. Definition of terms

The following terms and conditions apply to every order received by KNAUER and every delivery of goods. This holds as well in case of contradictory buying conditions of the purchaser. Exceptions are only valid when confirmed by KNAUER in writing. Purchase orders are only binding if confirmed by KNAUER in writing.

2. Payment

Deliveries are due and payable, net, within 30 days of invoice date or in advance. Deductions are not allowed. Foreign deliveries must be paid by irrevocable letter of credit or in advance. All bank and transfer fees must be paid by the customer. The consequences arising out of delay are due to statutory provisions. Payments are due irrespective of an eventual notice of defect, except such defects are evidently justified.

3. Delivery

Delivery dates are not binding unless expressly stated in the contract as binding dates. Delay in delivery requires a written reminder and an adequate additional grace period set by the customer. KNAUER is only liable for claims for damages under the requirements of no. 6.

4. Claims

Condition for any warranty claim is the immediate inspection of the goods upon delivery, and complaint towards and damage assessment together with the carrier, and an immediate written complaint to KNAUER. The complaint must be made within five workdays in case of visible defects or losses.

5. Risk liability

Delivery is made at the customer's own risk. As soon as the goods leave KNAUER's plant the risk of accidental loss, destruction or deterioration passes to the customer.

6. Warranty and damages

6.1. Warranty claims

The warranty begins with receipt of the goods. If commissioning has been ordered, after commissioning. In the case of delayed commissioning, the warranty begins at the latest four weeks after receipt of the goods unless the supplier is responsible for delayed commissioning.

The warranty for osmometers and liquid chromatography instruments is limited to two years, excluding glass breakage, damages due to stoppage and consumable materials such as membranes, light bulbs, columns, bushings, gaskets and valves. KNAUER's liability shall be restricted to the replacement of defective material or repair only. Transportation costs are borne by the customer. In case of failure of replacement or repair the customer may demand a reduction in price or cancellation of the contract with respect to the defective material. The customer has to inspect the goods delivered immediately and shall immediately give written notification of any defects to KNAUER, in case of non-obvious defects within 10 working days after delivery at the very latest.

6.2. Claims for damages

The liability of KNAUER shall be restricted to intentional acts and acts of gross negligence and compensation shall only be due for direct, foreseeable damages. Liability for breach of a material, essential duty of the contract, liability because of personal injury, liability according to the stipulations of the German Law on Product Liability and liability for the lack of the condition of the contract goods guaranteed by KNAUER remain unaffected.

7. Third party rights on industrial or other intellectual property

KNAUER shall not be liable for the infringement of third party rights founded on industrial or other intellectual property caused by the use of the delivered goods. The customer is fully responsible for the products manufactured with the goods. In particular KNAUER is not obliged to indemnify and hold harmless the customer from all claims raised by third parties based on the infringement of their industrial or intellectual property rights by the use of the goods.

8. Property rights

The ownership of the goods shall remain with KNAUER until payment in full for all our claims resulting from our business relation is received. In case of improper treatment of the goods or in case of default KNAUER may demand the return of the delivered goods. This demand entails resignation of the contract only if KNAUER declares it explicitly.

Resellers are allowed to sell the goods to third parties in due course of the business. The customer herewith assigns his resale claims against third parties to KNAUER.

9. Export

Instruments and products delivered by KNAUER may not be exported to a country other than of the customer's headquarters without KNAUER's prior written permission.

10. Place of settlement and court of jurisdiction

The place of performance is Berlin. Proper venue for all claims is the competent local court at KNAUER's principal place of business - Berlin. KNAUER reserves the right to sue the customer at his principal place of business.

This agreement shall be governed by the laws of the Federal Republic of Germany excluding the UN-Convention on the International Sale of Goods (CISG).

KNAUER Wissenschaftliche Geräte GmbH
Hegauer Weg 38
14163 Berlin, Germany

These terms and conditions apply since June 1, 2016

Notes

A series of horizontal dotted lines for taking notes.

KNAUER Brochures

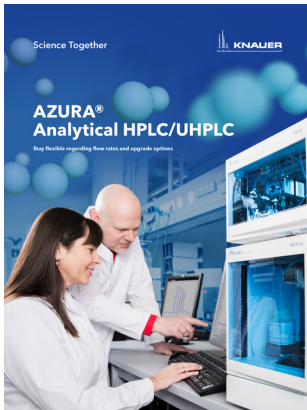

AZURA® Analytical HPLC/UHPLC
(Document no. V7852US)



AZURA® Bio purification
(Document no. V7855US)

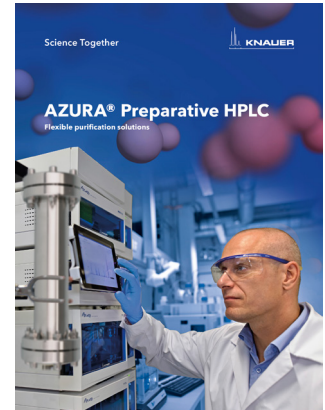

AZURA® Preparative HPLC
(Document no. V7820US)



AZURA® SMB systems
(Document no. V7741US)



Freezing point osmometry
(Document no. V7716US)

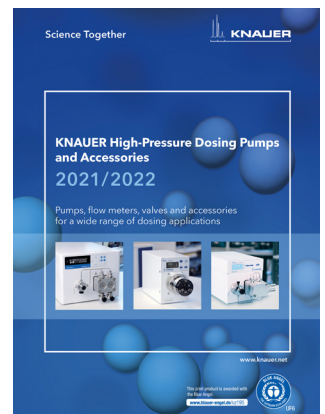

KNAUER Dosing Pump Selection Guide
(Document no. V7866US)



KNAUER LNP Flyer
(Document no. V7720US)



KNAUER OEM Brochure
(Document no. V7712US)

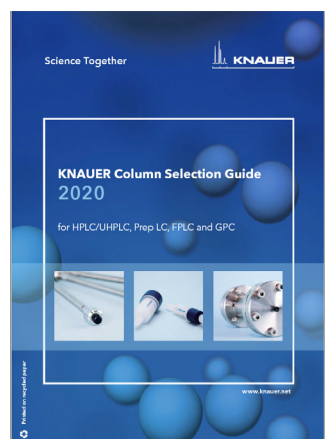

KNAUER Column Selection Guide
(Document no. V7803US)



All KNAUER brochures:
www.knauer.net/brochures

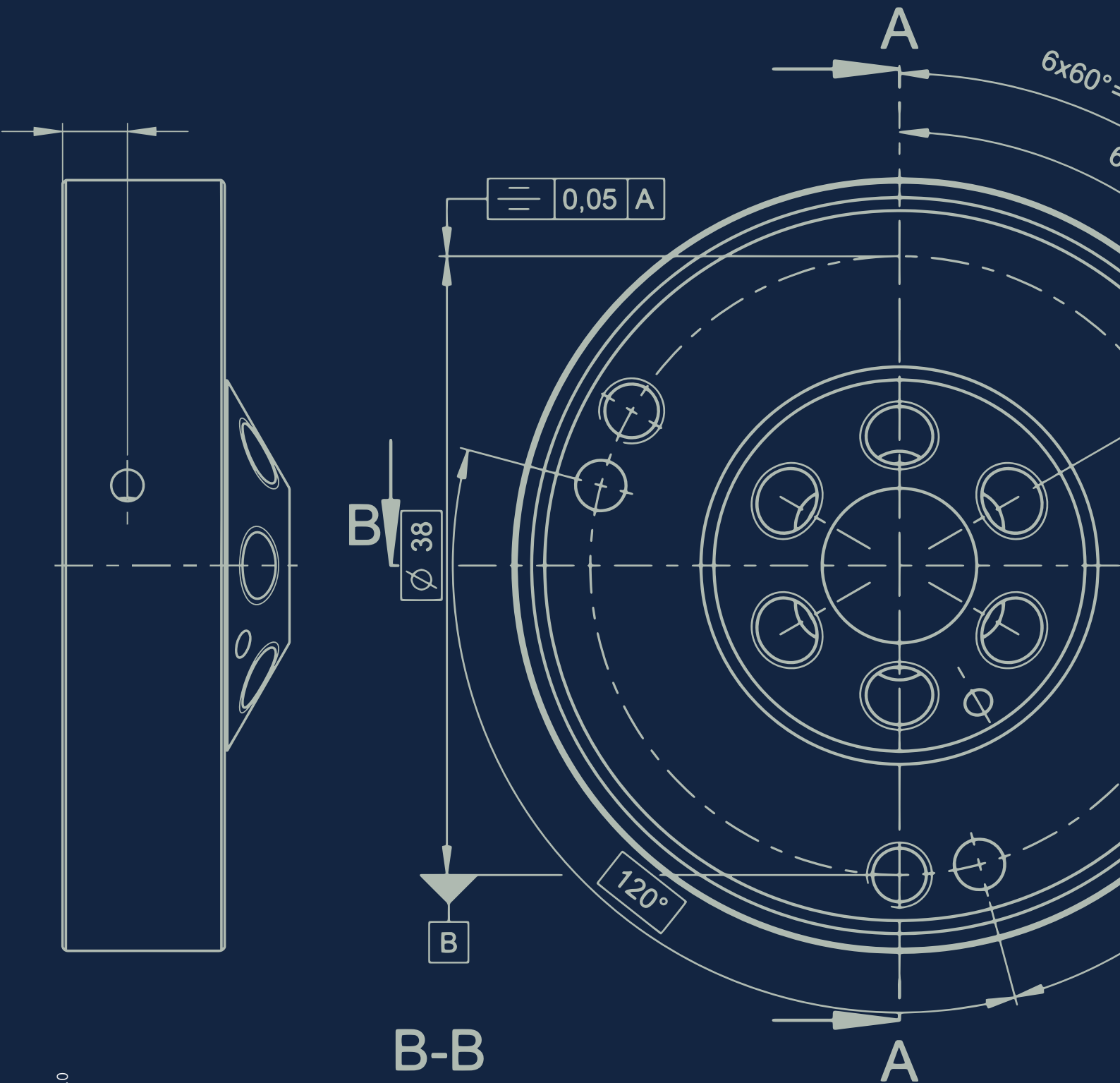

KNAUER

Wissenschaftliche Geräte GmbH
 Hegauer Weg 38
 14163 Berlin, Germany

+49 30 809727-0
 +49 30 8015010 (Fax)

info@knauer.net
 www.knauer.net

CEO

Alexandra Knauer, CEO
 Carsten Losch, CEO

Commercial register

Berlin-Charlottenburg
 Register No.: 93 HRB 15674
 VAT-ID-No.: DE136737469
 EORI Number DE 2620448
 DUNS Nr. 31-790-0785

